



2610 Commerce Rd
 Rapid City SD 57702
 1-605-342-7644
 Fax 1-605-342-4036
 www.warneusa.com

2025 Equipment and Parts Catalog

Spraying Equipment
UTV and ATV Application Equipment
Fire Fighting Units
Custom Built Sprayers
Pumps – Tanks – Hose – Lots and Lots of Parts
Liquid Fertilizer Application Equipment

<p>Contents Backpack Sprayers & Accessories 37 Booms & Accessories 36 Chemical Injectors 60 Chemical Mixing Unit 58 Clamps 7 Dosatron Chemical Injectors 60 Drainzit 59 Electric Sprayer Monitors & Components 34-35 Engines 59 Fertilizer Banding Kit 58 Fire Fighting Units & Accessories 52-53 Fittings 2-9 Flatbed Ladder 36 Fluid Film 62 Foam Markers & Accessories 36 Fogger 51 Forage Applicator 58</p>	<p>Gauges 13 Gopher Getter 58 GPS Guidance System 33 Grass Seeder 62 Handguns 12-13 Hose Reels & Accessories 16-17 Jet Rinse 62 Liquid Feed Applicator Kit 58 Measuring Containers 62 Miracle Rust Away 62 Mist Sprayers 51 Nozzles & Tips 12, 26-28, 32 Nurse Tank Trailer 43 Personal Protection Equipment 61 Planter Kits 58 Prairie Dog Baiter 58 Pumps & Accessories 18-25 Raven Parts 34</p>	<p>Root Feeders 62 Rust Away 62 Seed Treater 58 Seeders 60, 62 Soil Core Sampler 62 Sprayers 42-57 Spreaders & Accessories 60 Strainers 10-11 Surge Buster 41 Switch Boxes 34 Swivels 13 Tanks & Accessories 38-41 TeeJet Accessories 26-31 Tips & Nozzles 12, 26-28, 32 Totes 40 Valves 14-15 Weed Wiper 62 Wind Meter 62</p>
---	---	---



POLICIES, TERMS, AND CONDITIONS

Warne Companies wants to express our appreciation for your business. We are committed to a combination of high-quality product lines, knowledgeable sales staff, and prompt service at competitive prices. We will continue to do our very best to provide the same high standards of product and service you have come to expect from us.

PRICES

Prices shown are FOB Rapid City SD unless otherwise specified and are current to the best of our knowledge. However, prices may change at any time without notice or obligation as some of our suppliers implement price changes throughout the year. The prices charged will be the current pricing at the time of shipment. If you have any questions, please contact us. Starred (*) items are net prices.

TERMS

All orders are sold on a cash, credit card or COD basis unless an open account has been established prior to order for those firms with established financial standings. All products are invoiced NET DUE UPON RECEIPT. Freight charges will be "freight collect". Interest on past due account balances will be 1.5% per month. All payments on accounts will be posted to interest first and principal last.

ORDERS

All orders must contain a billing name and address, shipping name and address (UPS, FedEx, and common carrier require physical address, no PO Box numbers); name of person placing order and telephone number; and a purchase order number if applicable.

SALES TAX

Sales tax is a continual problem. Therefore, we ask you to notify us with your tax number each year. If we do not have your tax number on file, or you fail to give us your tax number while ordering, sales tax will be charged.

CHECK MERCHANDISE IMMEDIATELY UPON RECEIPT

If a shipment is received damaged or there is a shortage, note on the carrier's receipt. Report any problems to Warne Companies immediately.

MERCHANDISE RETURN FOR CREDIT

Merchandise may be returned for credit only upon authorization by Warne Companies. Upon authorization, a return merchandise authorization (RMA) number will be issued, and merchandise must be returned freight prepaid within thirty (30) days of purchase. Returns made thirty (30) days after purchase date will be assessed a 20% restock charge. All returns must indicate invoice number and date of purchase. Credit will be issued for the net invoice cost less all allowances, freight charges, a handling charge and additional charges for any items not received in saleable condition. Special orders cannot be returned. The final credit issued, in any event, will be subject to Warne Companies inspection to determine the condition.

QUOTES

We encourage our customers to call for specific quotes on materials. This insures you of the latest prices and we will honor all quotes for thirty (30) days.

**WARNE COMPANIES RESERVES THE RIGHT TO MAKE CHANGES IN PRICE AND/OR DESCRIPTIONS
SHOULD AN ERROR BE FOUND ~ PRICES EFFECTIVE JANUARY 1, 2025**

Warne Companies

2610 Commerce Rd, Rapid City SD 57702
605-342-7644
www.warneusa.com



2025 FEATURED PRODUCTS



For standard features and options see page 46

Warne Bale Bed Ready Sprayer

Designed for bale bed trucks with a variety of pump options. Units to be picked up by a bale bed unit or fork pockets for skid steer / forklift. 200-gallon poly tank. Many uses including fire fighting, cattle spraying, weed spraying, tree spraying, etc.

Custom Built Spray Units

We specialize in designing and building custom spraying equipment tailored to your specific needs. Whether you need a skid-mounted unit or a fully integrated system with a truck, we deliver precision-engineered solutions to enhance your operations.



Contact us today to discuss your custom build!

25-Gallon Aquatic Weed Spray Unit

WCAQ25 \$949.00

Designed for aquatic weed control applications

Features and pricing on page 50



Typhoon 3

Rechargeable Electric 4-Gallon Capacity Unit



The most comfortable and advanced backpack sprayer ever!

For features see page 37

Truck Mounted Hand Sprayer Holder \$58.00 each



- Safely and securely holds hand sprayer up to 9" diameter
- Sprayer sold separately

More information on page 37



Backpack Bracket \$163.00



Includes 5050L-B mount and steel base for truck bed or flatbed mounting. Backpack sold separately.

See page 37

WARNE'S BOOM BLASTER BOOMLESS NOZZLES

Great For

- Roadside
- Noxious weed control
- Handgun work



Features and pricing on page 32

IBC Dispensing Stand \$517.00

- 52.25" x 45.25" x 27.25"



See page 40

Hand Boom Assy

WC-HBA \$168.00 each

Designed to save time and conserve product. Accurately apply fluid with a consistent spray pattern.



See page 12

BLUMHARDT NYLON PARTS & FITTINGS

Acronym

FGHT	Female Garden Hose Thread	MGHT	Male Garden Hose Thread
FPT	Female Pipe Thread	MPT	Male Pipe Thread
FSPT	Female Straight Pipe Thread (Blumhardt)	MSPT	Male Straight Pipe Blumhardt Thread
FTL	Female Twist Lock	Mtg Sp	Mounting Space
HB	Hose Barb	MTL	Male Twist Lock







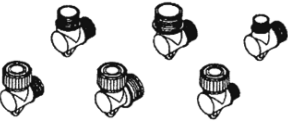
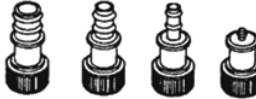











Diagram	Part #	Description	Price
	45947	Manifold block	3.78
	45949	Manifold cap	.71
	55729	1" tube mounting block	3.42
	55730	1" tube mounting block cap	2.28
	44457	1" nut x 2-1/4" coupler	9.80
	44491	1" nut x 3-1/2" coupler	9.80
	50165	Blumhardt II twist lock nozzle assembly with self-aligning cap (not for boomless nozzles)	18.85
	56405	Nozzle assembly with self-aligning cap with 50 mesh screen without tip	24.50
	46133	1" MSPT plug	2.95
	46134	1" FSPT cap	3.39
	51626	Universal twist lock cap	3.26
	51643	Blank FTL cap	2.85
	51644	FTL x self-aligning cap	2.85
	67577	FTL x TeeJet spray cap	2.85
	45965	1" MSPT x 1/2" MPT reducer	3.40
	45968	1" MSPT x 3/4" MPT reducer	3.50
	45970	1" MSPT nipple	3.50
	45971	1-1/4" MPT x 1" MSPT reducer	3.86
	45985	1" MSPT x 1" MPT adapter	3.61
	45990	1" MSPT x 1/4" MPT adapter	3.40
	46080	1" MSPT four-way cross	7.41
	46090	1" MSPT x 1-1/4" MPT x 1" MSPT tee	4.21
	46099	1" MSPT x 3/4" MPT x 1" MSPT tee	4.03
	46100	1" x 1" x 1" MSPT tee	3.71
	44553	1" MSPT x 1" nut x 1" MSPT tee	7.01
	44554	1" nut x 3/4" MPT x 1" MSPT tee	7.04
	44557	1" nut x 1" MSPT x 1" MSPT tee	6.90
	47872	1-1/4" MPT x 1" MSPT (3) four-way cross	9.24
55293	1" nut x 1" MSPT x 1" nut tee	10.42	
	44565	1" nut x 1" MSPT elbow	6.90
	44567	1" nut x 1/2" MPT elbow	7.01
	44568	1" nut x 3/4" MPT elbow	6.89
	46102	1" MSPT elbow	3.64
	46104	1" MSPT x 3/4" MPT elbow	3.78
	58276	1" MSPT x 1" MPT elbow	3.68
	46105	1" MSPT x 1/2" MPT elbow	3.71
	46111	1" MSPT x 1-1/4" MPT elbow	4.03
	46112	1" MSPT x 1-1/2" MPT elbow	4.03
51638	Twist lock nozzle elbow	3.68	
	44478	1" nut x mtg sp x 1/2" HB adapter	6.87
	44479	1" nut x mtg sp x 11/16" HB adapter	6.90
	44480	1" nut x mtg sp x 1" HB adapter	7.03
	47900	1" nut x mtg sp x 1/4" HB adapter	6.71

Diagram	Part #	Description	Price
	44475	1" nut x mtg sp x 3/4" MPT adapter	7.01
	44476	1" nut x mtg sp x 1" MSPT adapter	6.87
	44484	1" nut x mtg sp x 1" MPT adapter	7.13
	45922	1" MSPT x 1" mtg sp x 1/2" HB adapter	3.67
	45923	1" MSPT x 1" mtg sp x 11/16" HB adapter	3.71
	45924	1" MSPT x 1" mtg sp x 1" HB adapter	3.89
	45939	1" MSPT x 1" mtg sp x 1/4" HB adapter	3.64
		45928	1" MSPT x mtg sp x 1/2" MPT adapter
45929		1" MSPT x mtg sp 3/4" MPT adapter	3.86
45930		1" MSPT x mtg sp x 1" MPT adapter	3.86
45931		1" MSPT x mtg sp x 1" MSPT adapter	3.89
	44493	1" nut x 3/8" HB adapter	6.30
	44495	1" nut x 1" HB adapter	6.41
	44496	1" nut x 1/2" HB adapter	6.29
	44497	1" nut x 11/16" HB adapter	6.51
	44499	1" nut x 1/4" HB adapter	5.99
	60303	1" nut x 3/4" HB adapter	6.51
	46009	1" MSPT x 3/8" HB adapter	3.07
	46010	1" MSPT x 1/2" HB adapter	3.28
	46011	1" MSPT x 11/16" HB adapter	3.39
	46012	1" MSPT x 1" HB adapter	3.54
	44494	1" nut x 3/4" MPT adapter	6.71
	44500	1" nut x 7/16" MSPT adapter	5.99
	44506	1" nut x 1/2" MPT adapter	6.45
	44507	1" nut x 1" MPT adapter	6.75
44509	1" nut x 1" MSPT adapter	6.82	
	44503	1" nut x 1/8" FPT adapter	6.54
	44512	1" nut x 1/4" FPT adapter	6.47
	45055	1" nut x 3/4" FPT adapter	6.64
	45901	Metering orifice - red	1.43
	45902	Metering orifice - white	1.43
	45907	Metering orifice - blue	1.31
	45919	Metering orifice - green	1.31
	45920	Metering orifice - yellow	1.31
	45925	Metering orifice - purple	1.31
	45938	Metering orifice - black	1.31
	45955	Metering orifice - pink	1.31
	45980	Metering orifice - brown	1.31
	46002	Metering orifice - orange	1.31
46014	Metering orifice - olive	1.31	
	46336	.060" restrictor - yellow	.50
	46114	3/8" slip cap for tube holder - red	.88
	45943	1" Manifold head FSPT with six 1/4" HB outlets	3.68
	46118	1/4" HB plug	.48
	46122	Orifice sleeve	.60
	46129	Swivel nut	2.48
	44571	Orifice sleeve with nut	4.31
	44580	Screen body with check and 50 mesh screen	8.75
	46128	Screen body insert	.64
	46120	Tank webbing tie down nut	2.53
	46121	Tank webbing tie down bracket	5.36
	46716	Tank webbing, 1-3/4" polyester	3.00 / ft
	03728	Tank webbing, 4" polyester	5.05 / ft
	05748-95	4" anchor and bolt, metal	15.53
	05785-95	2" anchor and bolt	10.16
	222799	Retro fit spring and chain, one side	115.05 /side
	45495	Extension bracket	12.96

POLY FITTINGS

Abbreviations

FGHT – Female Garden Hose Thread
 FPT – Female Pipe Thread
 HB – Hose Barb
 MGHT – Male Garden Hose Thread
 MPT – Male Pipe Thread

Adapter – FPT x HB

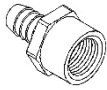

Order No	FPT	HB	Price
TAF1024PP	1/8	1/4	\$2.84
TAF1044PP	1/4	1/4	2.85
TAF1046PP	1/4	3/8	2.93
TAF1084PP	1/2	1/4	2.91
TAF1088PP	1/2	1/2	2.20
TAF10812PP	1/2	3/4	2.93
TAF10128PP	3/4	1/2	3.40
TAF101212PP	3/4	3/4	2.93
TAF101210PP	3/4	5/8	2.68
TAF101616PP	1	1	5.45

Adapter – FPT x MGHT

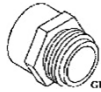

Order No	Thread	Price
GFA128PP	1/2	\$3.35
GFA1212PP	3/4	2.68

Adapter – MGHT x HB

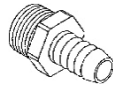

Order No	Size	Price
GA104PP	1/4	\$0.89
GA106PP	3/8	.87
GA1012PP	3/4	.90

Adapter – MPT x FGT



Order No	Size	Price
FGP12PP	3/4	\$2.85

Adapter – MPT x HB

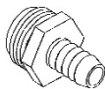

Order No	MPT	HB	Price
TA1024PP	1/8	1/4	\$0.57
TA1026PP	1/8	3/8	.57
TA1044PP	1/4	1/4	.57
TA1046PP	1/4	3/8	.57
TA1048PP	1/4	1/2	.58
TA1064PP	3/8	1/4	.58
TA1066PP	3/8	3/8	.62
TA1068PP	3/8	1/2	.64
TA1084PP	1/2	1/4	.64
TA1086PP	1/2	3/8	.69
TA1088PP	1/2	1/2	.64
TA10810PP	1/2	5/8	.67

Adapter – MPT x HB Continued

Order No	MPT	HB	Price
TA10812PP	1/2	3/4	\$0.69
TA10816PP	1/2	1	2.42
TA10124PP	3/4	1/4	.83
TA10126PP	3/4	3/8	.83
TA10128PP	3/4	1/2	.83
TA101210PP	3/4	5/8	.83
TA101212PP	3/4	3/4	.83
TA101216PP	3/4	1	1.24
TA101612PP	1	3/4	1.56
TA101616PP	1	1	1.92
TA101620PP	1	1-1/4	2.30
TA102012PP	1-1/4	3/4	2.97
TA102016PP	1-1/4	1	2.57
TA102020PP	1-1/4	1-1/4	2.86
TA102024PP	1-1/4	1-1/2	3.16
TA102420PP	1-1/2	1-1/4	2.98
TA102424PP	1-1/2	1-1/2	3.56
TA102432PP	1-1/2	2	12.15
TA103224PP	2	1-1/2	10.14
TA103232PP	2	2	4.07
TA104848PP	3	3	14.18

Adapter – Nipple MGHT x MPT



Order No	Thread	Price
GPN8PP	1/2	\$0.92
GPN12PP	3/4	.92

Adapter – Tank Outlet

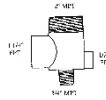

Order No	MPT	FPT	MPT	FPT	Price
T20CMPP	2	1/2	3/4	1-1/4	\$20.97

Bushing – Extender



Order No	British	MPT	Price
40014	1-1/4	1-1/2	\$3.71

Order No	FPT	MPT	Price
40003	1-1/2	1-1/4	\$3.86
40013	2	1-1/4	5.21
40004	2	1-1/2	5.21
40008	1-1/4	1/1-4	5.21
40010	2	2	5.21
40017	1-1/4	1-1/2	5.21

Cap – FPT



Order No	FPT	Price
HD4PP	1/4	\$0.63
HC6PP	3/8	.85
HC8PP	1/2	.85
HC12PP	3/4	.85

Order No	FGHT	Price
GHC12PP	3/4	2.37

Coupling – FPT

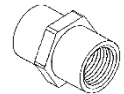

Order No	FPT	Price
CC88PP	1/2	\$4.32
CC1212PP	3/4	4.32
CC1616PP	1	9.24
CC2020PP	1-1/4	11.58
CC2424PP	1-1/2	8.77
CC3232PP	2	9.64
CC4848PP	3	30.35

Cross – 4 Way FPT



Order No	FPT	Price
CR8PP	1/2	\$23.04
CR12PP	3/4	23.04
CR16PP	1	23.04
CR20PP	1-1/4	34.31
CR24PP	1-1/2	34.31
CR32PP	2	35.00

Elbow – 90 Street



Order No	MPT	FPT	Price
SE44PP	1/4	1/4	\$2.97
SE66PP	3/8	3/8	3.19
SE88PP	1/2	1/2	2.97
SE1212PP	3/4	3/4	5.13
SE1616PP	1	1	6.20
SE2020PP	1-1/4	1-1/4	8.37
SE2424PP	1-1/2	1-1/2	12.50
SE3232PP	2	2	15.00
SE4848PP	3	3	53.98

Elbow – 45 Street



Order No	MPT	FPT	Price
SEQ1212PP	3/4	3/4	\$4.63
SEQ1616PP	1	1	12.06
SEQ2020PP	1-1/4	1-1/4	16.45
SEQ2424PP	1-1/2	1-1/2	16.85
SEQ3232PP	2	2	18.95
SEQ4848PP	3	3	76.20

Elbow – FPT



Order No	FPT	Price
EL88PP	1/2	\$5.72
EL1212PP	3/4	5.42
EL1616PP	1	8.90
EL2020PP	1-1/4	8.85
EL2424PP	1-1/2	13.22
EL3232PP	2	13.50
EL4848PP	3	62.86

POLY FITTINGS Continued

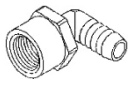
Elbow – FPT x HB 

Order No	MPT	FPT	Price
TEF2088PP	1/2	1/2	\$2.43
TEF20128PP	3/4	1/2	3.50
TEF201212PP	3/4	3/4	2.65
TEF201210PP	3/4	5/8	3.19

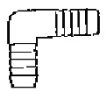
Elbow – HB x HB 

Order No	HB	Price
TEB2044PP	1/4	\$0.96
TEB2066PP	3/8	1.00
TEB2088PP	1/2	1.05
TEB201010PP	5/8	1.22
TEB201212PP	3/4	1.45
TEB201616PP	1	2.15
TEB202020PP	1-1/4	8.27
TEB202424PP	1-1/2	8.27
TEB203232PP	2	15.40

Elbow – MPT x HB 

Order No	MPT	HB	Price
TE2024PP	1/8	1/4	\$0.98
TE2044PP	1/4	1/4	1.04
TE2046PP	1/4	3/8	1.05
TE2048PP	1/4	1/2	1.06
TE2064PP	3/8	1/4	1.05
TE2066PP	3/8	3/8	1.11
TE2068PP	3/8	1/2	1.09
TE2084PP	1/2	1/4	1.18
TE2086PP	1/2	3/8	1.13
TE2088PP	1/2	1/2	1.13
TE20810PP	1/2	5/8	1.44
TE20812PP	1/2	3/4	1.48
TE20816PP	1/2	1	2.32
TE20124PP	3/4	1/4	1.30
TE20126PP	3/4	3/8	1.50
TE20128PP	3/4	1/2	1.51
TE201210PP	3/4	5/8	1.58
TE201212PP	3/4	3/4	1.58
TE201216PP	3/4	1	1.77
TE20168PP	1	1/2	2.18
TE201612PP	1	3/4	1.97
TE201616PP	1	1	1.97
TE202012PP	1-1/4	3/4	5.74
TE202016PP	1-1/4	1	4.63
TE202020PP	1-1/4	1-1/4	4.18
TE202024PP	1-1/4	1/1/2	4.04
TE202424PP	1-1/2	1-1/2	5.64
TE203224PP	2	1-1/2	12.80
TE203232PP	2	2	4.96
TE204848PP	3	3	39.50

Hex Head Plug – MPT 

Order No	MPT	Price
TP4002PP	1/8	\$0.55
TP4004PP	1/4	.55
TP4006PP	3/8	.58
TP4008PP	1/2	.65
TP4012PP	3/4	.71
TP4016PP	1	.96
TP4020PP	1-1/4	2.56
TP4024PP	1-1/2	2.76
TP4032PP	2	3.64
TP4048PP	3	26.50

Hose Shank for Style "B" Swivel Nuts 

Order No	Size	Price
GHA4PP	1/4	\$0.56
GHA6PP	3/8	.58
GHA8PP	1/2	.62
GHA12PP	3/4	.67

Washer Flat Garden Thread 

Order No	Price
PVC Black	\$0.29
Leather	2.20

Swivel Nut with FGHT 

Order No	Size	Price
GHN12PP	3/4	\$0.73

Manifold 

Order No	Size	Size	Price
M1284	3/4	1/2	\$38.96

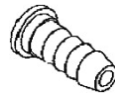
Hose Shank for 8027 

Order No	Thread	Price
T3614PP	1/4	\$0.58
T3638PP	3/8	.56
T3612PP	1/2	.65

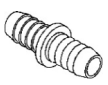
Mender – HB x HB 

Order No	HB	HB	Price
TC7044PP	1/4	1/4	\$0.58
TC7066PP	3/8	3/8	.64
TC7088PP	1/2	1/2	.67
TC71010PP	5/8	5/8	.75
TC71212PP	3/4	3/4	.94
TC71616PP	1	1	1.23
TC72020PP	1-1/4	1-1/4	3.03
TC72424PP	1-1/2	1-1/2	3.38
TC73232PP	2	2	9.91
TC74848PP	3	3	20.35
TRC8086PP	1/2	3/8	.75

Nipple – MPT x MPT 

Order No	MPT	MPT	Price
TN5044PP	1/4	1/4	\$0.60
TN5066PP	3/8	3/8	.63
TN5088PP	1/2	1/2	.67
TN51212PP	3/4	3/4	.86
TN51616PP	1	1	1.27
TN52020PP	1-1/4	1-1/4	2.61
TN52424PP	1-1/2	1-1/2	4.26
TN53232PP	2	2	5.81
TN504848PP	3	3	16.89

Nipple – Reducing MPT x MPT 

Order No	MPT	MPT	Price
TRN6064PP	3/8	1/4	\$0.76
TRN6084PP	1/2	1/4	.64
TRN6086PP	1/2	3/8	.64
TRN60126PP	3/4	3/8	.92
TRN60128PP	3/4	1/2	.81
TRN601612PP	1	3/4	5.97
TRN602016PP	1-1/4	1	6.18
TRN602420PP	1-1/2	1-1/4	6.59
TRN603224PP	1-1/2	2	7.32
TRN604832PP	3	2	25.10

Nozzle Body Cross 

Order No	HB	Price
T01CRPP	3/8	\$2.81
T03CRPP	1/2	2.75

Nozzle Body Elbow 

Order No	HB	Price
T01ELPP	3/8	\$1.73
T03ELPP	1/2	1.78
T04ELPP	3/4	2.44

POLY FITTINGS Continued

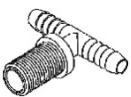
Nozzle Body Tee 

Order No	HB	Price
T01TEPP	3/8	\$1.84
T03TEPP	1/2	1.94
T04TEPP	3/4	2.58

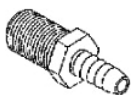
Nozzle Straight Hose Barb 

Order No	Thread	Price
T01STPP	3/8	\$1.24
T03STPP	1/2	1.29

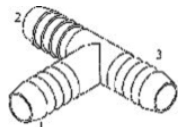
Tee HB x HB x HB 

Order No	HB 1	HB 2	HB 3	Price
TT9444PP	1/4	1/4	1/4	\$1.19
TT9666PP	3/8	3/8	3/8	1.08
TT9888PP	1/2	1/2	1/2	1.18
TT9101010PP	5/8	5/8	5/8	1.35
TT9121212PP	3/4	3/4	3/4	1.44
TT9161616PP	1	1	1	1.91
TT9202020PP	1-1/4	1-1/4	1-1/4	4.97
TT9242424PP	1-1/2	1-1/2	1-1/2	6.51
TT9323232PP	2	2	2	15.60
TT9688PP	3/8	1/2	1/2	1.08
TT9866PP	1/2	3/8	3/8	1.18
TT91288PP	3/4	1/2	1/2	4.58
TT9484848PP	3	3	3	30.43

Reducer Bushings MPT x FPT 

Order No	MPT	FPT	Price
RB62PP	3/8	1/8	\$2.59
RB64PP	3/8	1/4	1.50
RB84PP	1/2	1/4	1.72
RB86PP	1/2	3/8	1.54
RB122PP	3/4	1/8	2.54
RB124PP	3/4	1/4	1.88
RB126PP	3/4	3/8	1.88
RB128PP	3/4	1/2	1.88
RB168PP	1	1/2	2.26
RB1612PP	1	3/4	1.94
RB2012PP	1-1/4	3/4	4.59
RB2016PP	1-1/4	1	4.59
RB2412PP	1-1/2	3/4	4.67
RB2416PP	1-1/2	1	4.86
RB2420PP	1-1/2	1-1/4	5.69
RB3212PP	2	3/4	10.43
RB3216PP	2	1	6.90
RB3220PP	2	1-1/4	6.30
RB3224PP	2	1-1/2	5.69
RB4832PP	3	2	14.16

Tee Female Pipe Thread 

Order No	FPT	Price
TT4PP	1/4	\$4.61
TT8PP	1/2	4.48
TT12PP	3/4	6.47
TT16PP	1	12.43
TT20PP	1-1/4	17.26
TT24PP	1-1/2	20.56
TT32PP	2	25.63
TT48PP	3	61.14

Tee - Gauge 

Order No	FPT	Port	Price
TT84PP	1/2	1/4	\$5.73
TT124PP	3/4	1/4	6.50
TT164PP	1	1/4	22.40

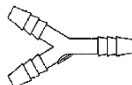
Y Hose Barb 

Order No	HB	Price
TTY222PP	1/8	\$5.30
TTY444PP	1/4	3.52
TTY666PP	3/8	3.59

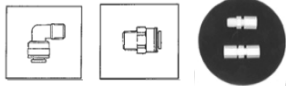
Compression Gauge Fittings 

Order No	Description	Price
1181	1/8 MPT x 1/8 Line	\$8.25
JGME24BP	1/8 MPT 90 x 1/4 Line	5.63
1182	1/8 Union FTG	8.25
JGMC24BP	1/8 MPT x 1/4 Line	4.27
084-333006	1/4 FPT x 1/4 Line	8.92
084-333007	1/4 MPT x 1/4 Line	5.05
084-333008	1/4 Line union	6.18
JGME44BP	1/4 MPT 90 x 1/4 Line	4.11

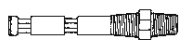
Jet Agitators 

Order No	Thread	Price
045 3371	1/2" FPT	\$10.50
045 371019	3/4" MPT	10.85
045 371028	3/4" MPT 5:1	64.35

Mini Agitators 

Order No	Description	Price
WCMINI01	Nylon body	\$56.00

Pipe Sealant 

Order No	Description	Price
036 4X543	Tape, 520"	\$2.27
150R STB2	Tru Blu, 2 oz	12.50
150R STB	Tru Blu, 8 oz	27.50

Drum Faucets 

Order No	Description	Price
F6775	3/4"	\$5.75
F6783	1"	8.40
F6784	2"	29.40

FLANGE FITTINGS AND CLAMPS

Hose Barbs



CP48150-PP	1" Flange x 3/4" hose barb	\$3.07
CP45504-PP	1" Flange x 1" hose barb	3.07
CP45505-PP	1" Flange x 1-1/4" hose barb	3.07
CP45506-PP	1" Flange x 1-1/2" hose barb	3.46
CP46067-PP	2" Flange x 1-1/2" hose barb	8.13
CP48160-PP	2" Flange x 1-1/4" hose barb	8.13
CP48161-PP	2" Flange x 2" hose barb	8.13
M220BRB	220 Flange x 2" hose barb	7.01
M300BRB	3" x 3" hose barb	21.42

90° Hose Barbs



CP48151-PP	1" Flange x 3/4" 90° hose barb	\$3.17
CP48152-PP	1" Flange x 1" 90° hose barb	3.77
CP48162-NYB	2" Flange x 1-1/4" 90° hose barb	13.76
CP48163-NYB	2" Flange x 1-1/2" 90° hose barb	13.76
CP48164-NYB	2" Flange x 2" 90° hose barb	13.76
MF3216BRBE	2" x 1" hose barb	21.22
MF32FPBRBE	2" FP x 2" hose barb	21.24
M220BRBWP90	220 Flange x 2" 90° hose barb	22.00

Male NPT



CP48172-PP	1" Flange x 3/4" male NPT	\$3.55
CP48155-PP	1" Flange x 1" male NPT	3.55
M100125M	1" Flange x 1-1/4" male NPT	6.30
CP48156-PP	1" Flange x 1-1/2" male NPT	3.83
CP48165-PP	2" Flange x 1-1/4" male NPT	7.20
CP48166-PP	2" Flange x 1-1/2" male NPT	7.20
CP48167-NYB	2" Flange x 2" male NPT	7.20
M220MPT	220 Flange x 2" MPT	6.81
M300MPT	3" x 3" MPT	18.93

Female NPT



CP45508-1/4-PP	1" Flange x 1/4" female NPT	\$3.96
CP45512-PP	1" Flange x 1-1/4" female NPT	3.96
CP45539-3/8-PP	1" Flange x 3/8" female NPT	3.96
CP48154-PP	1" Flange x 1" female NPT	3.55
CP46066-NYB	2" Flange x 1-1/2" female NPT	9.82
CP46127-1/4-PP	2" Flange x 1/4" female NPT	9.82
CP46127-3/8-PP	2" Flange x 3/8" female NPT	9.82
MF32PL-12	2" Flange x 3/4" FPT	30.68
MF32PL-16	2" Flange x 1" FPT	30.68

Blanks



CP45507-PP	1" Flange x blank	\$3.55
CP46069-NYB	2" Flange x blank	8.13

Stainless Steel Ball Valves

1/4", locking handle, use for petcock on centrifugal pumps

49001	1/8" stainless steel nipple	\$4.85
49020	1/4" stainless steel nipple	5.70
63500	1/4"x 1/8" reducer	6.65

2" Stainless Steel Fittings



SSTN53232CL	2" x 2" close nipple	\$20.70
SSTN54848CL	3" x 3" close nipple	53.05
SSSE3232	2" street elbow	95.22
62108	2" female elbow	68.30

Flange Clamps

FC100	1" Series stainless steel clamp	\$11.25
FC200	2" Series stainless steel clamp	12.95
FC220	220 stainless steel flange clamp	14.30

Universal Flange Clamps & Gaskets

Clam shell design, replaces Banjo and TeeJet clamps

FC100G	1" Flange clamp and gasket	\$12.75
FC200G	2" Flange clamp and gasket	14.50
FC220G	2" FP flange clamp and gasket	18.75

Gasket with wrap around feature for better sealing; fits Banjo

FG100	1" Flange gasket	\$2.31
FG200	2" Flange gasket	2.46
FG220	2" FP flange gasket	2.51

All Stainless Steel Clamps

Stainless steel bolt and housing. Use with fertilizers and chemicals.



Band Clamp:

Item	Range	Hose Size	Price
350-004	3/16" to 5/16"	1/4" & 3/8"	\$1.67
350-005	3/16" to 5/16"	3/8"	1.67
350-006	5/16" to 7/8"	1/2"	2.04
620-012	5/8" to 3/4"	3/4"	2.15
620-016	1-1/16" to 1-1/2"	1"	2.15
620-024	11/16" to 2"	1-1/4"	2.36
620-028	1-5/16" to 2-1/4"	1-1/2"	2.36
620-032	1-9/16" to 2-1/2"	2"	2.46
620-040	2-9/16" to 3"	---	2.67

Quick Release:

550-048	1-9/16" to 3-1/2"	2-1/2"	\$3.57
550-056	1" to 4"	3"	3.90
550-072	2" to 5"	---	4.20
550-104	4" to 8"	---	4.60
550-152	8" to 10"	---	6.00

T-Bolt Hose Clamps

Band and arch are stainless steel

TC206	1-1/2" T-Bolt	2.008 to 2.16	\$7.10
TC231	2" T-Bolt	2.48 to 2.67	8.20
TC343	3" T-Bolt	3.58 to 3.81	9.35



SmartSeal HD Clamps

5/8" band width. Stainless steel construction. 150 in/lbs ultimate torque. Spring compression of liner creates 360° pressure on hose.

PC238	1-1/2"	\$10.17
PC275	2"	10.59
PC400	3"	11.48



IRON FITTINGS

Iron Close Nipples		
Order No	NPT Size	Price
57001	1/8	\$2.32
57020	1/4	2.91
57040	3/8	3.14
57060	1/2 Close	2.18
57061	1/2 x 1-1/2	2.38
57070	1/2 / 6	4.77
57080	3/4	2.97
57100	1	4.34
57120	1-1/4	6.26
57140	1-1/2	6.79
57160	2	8.83

Iron Crosses		
Order No	NPT Size	Price
65390	1/8	\$27.97
65391	1/4	13.34
65392	3/8	13.34
65393	1/2	15.47
65394	3/4	21.40
65395	1	14.96
65396	1-1/4	20.64
65397	1-1/2	21.31
65398	2	35.58

Iron Couplings		
Order No	NPT Size	Price
65410	1/8	\$5.69
65411	1/4	5.20
65412	3/8	5.17
65413	1/2	5.79
65414	3/4	5.64
65415	1	7.26
65416	1-1/4	8.49
65417	1-1/2	11.15
65418	2	15.47

Iron Reducing Bushings		
Order No	NPT Size	Price
65504	1/2 x 1/4	\$8.91
65505	1/2 x 3/8	8.21
65507	3/4 x 1/4	5.01
65508	3/4 x 3/8	8.65
65509	3/4 x 1/2	7.38
65510	1 x 1/4	6.10
65511	1 x 3/8	5.76
65512	1 x 1/2	4.27
65513	1 x 3/4	4.27
65516	1-1/4 x 1/2	6.17
65517	1-1/4 x 3/4	6.07
65518	1-1/4 x 1	6.12
65521	1-1/2 x 1/2	6.83
65522	1-1/2 x 3/4	6.86
65523	1-1/2 x 1	7.15
65524	1-1/2 x 1-1/4	7.40
65529	2 x 1	9.90
65530	2 x 1-1/4	9.43
65531	2 x 1-1/2	9.90
65535	2-1/2 x 2	15.83

45 Iron Elbows FPT

Order No	NPT Size	Price
65180	1/8	\$6.71
65181	1/4	7.86
65182	3/8	6.57
65183	1/2	5.07
65184	3/4	6.43
65185	1	8.19
65186	1-1/4	13.77
65187	1-1/2	17.61
65188	2	25.58

90 Iron Elbows FPT

Order No	NPT Size	Price
65100	1/8	\$4.37
65101	1/4	3.61
65102	3/8	3.50
65103	1/2	2.77
65104	3/4	3.99
65105	1	7.35
65106	1-1/4	8.59
65107	1-1/2	15.05
65108	2	19.49

45 Iron Street Elbows

Order No	NPT Size	Price
65200	1/8	\$8.54
65201	1/4	6.02
65202	3/8	7.07
65203	1/2	5.68
65204	3/4	15.06
65205	1	13.54
65206	1-1/4	17.77
65207	1-1/2	28.82
65208	2	51.04

90 Iron Street Elbows

Order No	NPT Size	Price
65-160	1/8	\$5.37
65-161	1/4	7.91
65-162	3/8	6.27
65-163	1/2	6.68
65-164	3/4	6.81
65-165	1	10.06
65-166	1-1/4	11.82
65-167	1-1/2	18.37
65-168	2	25.39

Side Outlet Iron Tee

Order No	NPT Size	Price
65383	1/2	\$22.51
65384	3/4	30.09

Straight Iron Tee

Order No	NPT Size	Price
65250	1/8	\$5.48
65251	1/4	5.44
65252	3/8	5.19
65253	1/2	5.68
65254	3/4	8.42
65255	1	10.85
65256	1-1/4	16.58
65257	1-1/2	20.58
65258	2	28.22

MPT Iron Plug

Order No	NPT Size	Price
67771	1/4	\$1.50
67772	3/8	2.77
67773	1/2	4.81
67774	3/4	7.60
67775	1	10.82
67776	1-1/4	19.68
67777	1-1/2	27.46
67778	2	50.20



BRASS FITTINGS

45° Street Elbow

Use on Jackrabbit Pro

Order No	Size	Price
28231	1/4 MPT x 1/4 FPT	\$5.59

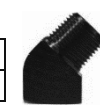

Garden Hose Nipples

Order No	Size	Price
30058	1/2 x 3/4 GHT	\$6.77
30063	3/4 x 3/4 GHT	8.14
30064	1 x 3/4 GHT	19.62
30065	1 x 1 GHT	52.41



Hose Barbs

Order No	Size	Price
30041	5/8 HB x MGHT	\$6.87
30042	3/4 HB x MGHT	6.65
32013	3/8 HB x 3/8 MPT	2.31
32014	3/8 HB x 1/2 MPT	5.42
32016	1/2 HB x 3/8 MPT	3.89
32017	1/2 HB x 1/2 MPT	5.07
32018	1/2 HB x 3/4 MPT	8.28
32023	3/4 HB x 3/4 MPT	8.96



Hose Barb 90

Use on Jackrabbit Pro

Order No	Size	Price
32042	3/8 HB x 3/8 MPT	\$6.59



Brass Needle Valve

Order No	Size	Price
46056	1/4	\$16.82

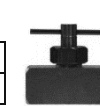

Forged 90° Street Elbow

Order No	Size	Price
28166	1/4	\$5.18
28167	3/8	7.80
28168	1/2	11.15



Compression Fittings

Order No	Size	Price
18007	1/2 Compression Sleeve	\$1.01
18159	1/2 FPTX x 1/2 COM	19.89
18194	3/8 MPT x 1/2 COM	7.18
18195	1/2 MPT x 1/2 COM	11.76



BRASS FITTINGS Continued

Swivel – FGH

Order No	Size	Price
30031	3/8 HB x 3/4 FGH	\$7.63
30505	1/2 HB x 3/4 FGH	11.76
30506	5/8 HB x 3/4 FGH	13.15
30507	3/4 HB x 3/4 FGH	11.68
30508	1 HB x 1 FGH	17.90



Swivel – FGH x Male NPT

Order No	Size	Price
30182	3/4 x 3/4	\$24.06
30183	3/4 x 1/2	12.53
30184	3/4 x 3/8	8.75



Plated Steel King Nipples

Order No	ID	Price
CNT-075-SP	3/4	\$5.73
CNT-100-SP	1	7.09
CNT-125-SP	1-1/4	8.99
CNT-150-SP	1-1/2	10.31
CNT-200-SP	2	12.02



Reducer Bushing

Order No	ID	Price
28107	1/2 MPT x 3/8 FPT	\$4.10
28111	3/4 MPT x 1/2 FPT	7.80



Vent Valve

Order No	ID	Price
46622	1/4 MPT x Air	14.35



POLYPROPYLENE CAM LEVER COUPLINGS

3/4"		1"		1-1/4"		1-1/2"		2"		3"		2" 90°	
075A	\$6.98	100A	\$6.98	125A	\$6.98	150A	\$7.92	200A	\$9.37	300A	\$18.07	---	
075B	\$15.96	100B	\$18.37	125B	\$18.37	150B	\$23.75	200B	\$26.21	300B	\$35.22	---	
075C	\$15.96	100C	\$18.37	125C	\$18.37	150C	\$23.75	200C	\$26.21	300C	\$35.22	200C90	\$35.13
075D	\$15.96	100D	\$18.37	125D	\$18.37	150D	\$23.75	200D	\$26.21	300D	\$35.22	200D90	\$35.13
075E	\$7.53	100E	\$8.39	125E	\$8.39	150E	\$8.41	200E	\$11.05	300E	\$23.18	200E90	\$17.67
075F	\$7.53	100F	\$8.39	125F	\$8.39	150F	\$8.41	200F	\$11.05	300F	\$23.18	200F90	\$17.67
075PL	\$7.53	100PL	\$7.53	125PL	\$7.53	150PL	\$8.12	200PL	\$10.97	300PL	\$18.39	---	
075CAP	\$15.96	100CAP	\$17.62	125CAP	\$17.62	150CAP	\$23.75	200CAP	\$26.21	300CAP	\$35.22	---	
24160Gasket	\$1.30	24260 Gasket	\$1.40	24360 Gasket	\$1.40	24460 Gasket	\$1.65	24560 Gasket	\$2.20	24760 Gasket	\$2.50	---	
---		Shims	\$1.30	Shims	\$1.30	Shims	\$1.55	Shims	\$2.10	Shims	\$2.40	---	

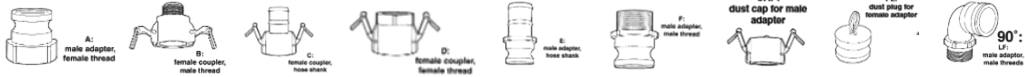

Adapter

3" female x 2" male
\$52.60



GARDEN HOSE CAM LEVER COUPLING



075A-NGHT	Male x Female Adapter GHT	\$8.08
075B-NGHT	Female Coupler x Male GHT	\$16.08



LANYARDS

11" Ring-to-Ring Lanyard	#2183	\$5.75
11" Ring-to-Ring Chain Lanyard	#SSC-08	\$9.15



PLATED CARBON STEEL HIGH PRESSURE HOSE FITTINGS

E014	3/8 HB x 1/2 MPT	\$ 7.10
E022	1/2 HB x 1/2 MPT	7.55
E028	5/8 HB x 1/2 MPT	17.00
E034	3/4 HB x 3/4 MPT	12.90
30032	1/2 HB x GHT Swivel	26.80
30033	5/8 HB x GHT Swivel	27.60
30034	3/4 HB x GHT Swivel	27.60
30040	1/2 HB x GHT	15.35



Stainless Steel Bandit Clamps

J202	3/8"	\$3.65
J204	1/2"	6.20
J205	5/8"	6.20

Shop Banding Fee: \$39.80* Includes clamps and hose fittings
\$69.80* With swivel fitting

HOSE BARBS

3/8" and 1/2" hose barbs with 1/2" fly nuts in straight and 90° configurations. May be used as inlets for UDOT spray guns and as outlets for most UDOT control units.







162.604.2	3/8" Straight	\$14.40
162.604.4	1/2" Straight	14.40
163.604.4	3/8" Elbow	16.00
163.604.6	1/2" Elbow	16.00

STRAINERS

Line & Suction Strainers

- Female ports, 40 mesh screens, and EPDM gaskets are all standard
- Clear bowl not recommended for use with alcohol

Poly Bowl	Mesh	Price	Size	Clear Bowl	Mesh	Price
RVF88PE20CP	20	\$19.50	1/2"	RVF88PE20CC	20	\$29.00
RVF88PE40CP	40	19.81	1/2"	RVF88PE40CC	40	29.00
RVF88PE80CP	80	19.81	1/2"	RVF88PE80CC	80	29.00
RVF1212PE20CP	20	19.50	3/4"	RVF1212PE20CC	20	34.50
RVF1212PE40CP	40	19.81	3/4"	RVF1212PE40CC	40	34.50
RVF1212PE80CP	80	19.81	3/4"	RVF1212PE80CC	80	34.50
RVF1616PE20CP+	20	22.50	1"	RVF1616PE20CC+	20	37.30
RVF1616PE40CP+	40	22.50	1"	RVF1616PE40CC+	40	37.30
RVF1616PE80CP+	80	22.50	1"	RVF1616PE80CC+	80	37.30
RVF1616PE20CP	20	40.90	1" large bowl	RVF1616PE20CC	20	59.40
RVF1616PE40CP	40	40.90	1" large bowl	RVF1616PE40CC	40	59.40
RVF1616PE80CP	80	40.90	1" large bowl	RVF1616PE80CC	80	59.40
RVF2020PE20CP	20	41.50	1-1/4" large	RVF2020PE20CC	20	59.68
RVF2020PE40CP	40	41.50	1-1/4" large	RVF2020PE40CC	40	59.68
RVF2020PE80CP	80	41.50	1-1/4" large	RVF2020PE80CC	80	59.68
RVF2424PE20CP	20	41.47	1-1/2" large	RVF2424PE20CC	20	59.96
RVF2424PE40CP	40	41.47	1-1/2" large	RVF2424PE40CC	40	59.96
RVF2424PE80CP	80	41.47	1-1/2" large	RVF2424PE80CC	80	59.96

1/2", 3/4" & 1"			1" Bowl			1-1/4"			1-1/2"		
	RVF88TPN	1/2" \$6.91	RVF1616TP	\$18.50	RVF2020TP	\$18.50	RVF2424TP	\$18.54			
	RVF1212TPN	3/4" 8.07									
	RVF1616TP*	1" 8.49									
	RVF66GE	EPDM \$1.35	RVF1616GE	EPDM \$1.35	RVF1616GE	EPDM \$1.35	RVF1616GE	EPDM \$1.35	RVF1616GE	EPDM \$1.35	
	RVF66GV	Viton 4.54	RVF1616GV	Viton 8.68	RVF1616GV	Viton 8.68	RVF1616GV	Viton 8.68	RVF1616GV	Viton 8.68	
	RVF6620C	20M \$10.73	RVF161620C	20M \$11.82	RVF202020C	20M \$13.85	RVF242420C	20M \$17.45	RVF242420C	20M \$17.45	
	RVF6640C	40M 10.73	RVF161640C	40M 11.82	RVF202040C	40M 13.85	RVF242440C	40M 20.94	RVF242440C	40M 20.94	
	RVF6680C	80M 12.81	RVF161680C	80M 16.61	RVF202080C	80M 16.15	RVF242480C	80M 23.13	RVF242480C	80M 23.13	
	RVF66BP	Poly \$7.47	RVF1616BP	Poly \$12.27	RVF1616BP	Poly \$12.27	RVF1616BP	Poly \$12.27	RVF1616BP	Poly \$12.27	
	RVF66BC	Clear 16.74	RVF1616BC	Clear 30.77	RVF1616BC	Clear 30.77	RVF1616BC	Clear 30.77	RVF1616BC	Clear 30.77	

Pump Suction Foot Valve Strainers

2" or 3"
cast iron
foot valve



FV-200 \$70.00
FV-300 125.00

3" High Volume Strainer



3" inlet and outlet
with 40 mesh strainer

300A-20 \$493.00

Replacement Screens
4S513-40 \$121.43
4S513-20 121.43

Inlet Strainer for Flojet Quad Port Pump with 40 Mesh Screen



3/4" HB x quad port 90°
O1740-010 \$4.00

Excellent strainer for use with Flojet 4300-504 4.9 gpm and 4400-504 4.5 gpm pumps.
No parts available.

The "Pump Saver"



- 1-1/2" inlet & outlet
- 16 mesh screen
- Brass mounting inserts
- Built-in check valve for filter cleaning
- Works well with diaphragm pumps

106625	1" straight	\$2.08
106633	1-1/4" straight	2.15
106638	1-1/2" straight	2.67

116625	1-1/2" elbow	\$ 2.71
116633	1-1/4" elbow	3.05
116638	1-1/2" elbow	3.86
2002060	Fly nut and gasket	4.70
3142561	1-1/2", 16 mesh	111.25
314000-040	Bowl retainer nut	17.25
314000-050	Bowl o-ring	12.18
314001-030	16 mesh screen	22.29
314003-030	50 mesh screen	22.29
314400-020	Filter cup	11.29
314500-010	Strainer upper body	60.20

Line Strainer for Flange Coupling with 50 Mesh Screen



AA126ML-F50-50	50 series flange	\$50.74
CP16903-3-SSPP	30 mesh screen	20.40
CP16903-4-SSPP	50 mesh screen	20.40
CP16903-5-SSPP	80 mesh screen	20.40
AA126M-F75-50	75 series flange	103.00
CP15941-2-SSPP	30 mesh screen	28.72
CP16941-3-SSPP	50 mesh screen	28.72
CP15941-4-SSPP	80 mesh screen	28.72

Y-Type Polypropylene Strainer

LS20050 2" FPT-50 mesh \$119.00
MLS20050 2" Flange-50 mesh \$145.00

Replacement screens

LS22055 20 mesh \$66.80
LS25055 40 mesh 66.80
LS28055 80 mesh 66.80
LS21255 12 mesh 66.80



1/2" Female Strainer for Jackrabbits



Standard 40 mesh screen, EPDM gaskets

RVLF88PE40CP	1/2" female, poly bowl	\$15.36
RVLM88PE40CP	1/2" male, poly bowl	\$15.36
RVLF88PE40CC	1/2" female, clear bowl	\$18.39
RVLM88PE40CC	1/2" male, clear bowl	\$18.39

Parts

RVLF88TP	Cap, female	\$6.34
RVM88TP	Cap, male	4.92
RVM44GE	Gasket, EPDM	1.77
RVM44GV	Gasket, Viton	2.15
RVM4440C	Screen, 40 mesh	7.92
RVM44BP	Bowl, poly	6.35
RVM44BC	Bowl, clear	9.58

Strainers Continued

2" Manifold Flange Y Strainer

- Heavy duty glass reinforced polypropylene • Clean out plug • EPDM gaskets; Viton available

Part #	Price Each	Description
MLS20012	\$145.79	2" standard port manifold Y strainer; 12 mesh ss screen
MLS20020	145.79	2" standard port manifold Y strainer; 20 mesh ss screen
MLS20030	137.50	2" standard port manifold Y strainer; 30 mesh ss screen
MLS20050	145.79	2" standard port manifold Y strainer; 50 mesh ss screen
MLS20080	145.79	2" standard port manifold Y strainer; 80 mesh ss screen
MLS22012	160.36	2" full port manifold Y strainer; 12 mesh ss screen
MLS22020	160.36	2" full port manifold Y strainer; 20 mesh ss screen
MLS22030	160.36	2" full port manifold Y strainer; 30 mesh ss screen
MLS22050	160.36	2" full port manifold Y strainer; 50 mesh ss screen
MLS22080	160.36	2" full port manifold Y strainer; 80 mesh ss screen



Replacement Parts For: 2" Manifold Flange Y Strainer

Item	Part #	Price Each	Description
1	MLS200B	\$44.96	2" Y strainer body
1	MLS220B	52.82	2" FP Y strainer body
2	LS150C	33.04	2" end cap (contains #1 #2 #3 #4)
3	LSP100	4.99	1" clean out plug
4	LSP100G	1.50	EPDM o-ring for 1-1/2" & 2" clean out plug
4	LSP100GV	2.55	Viton o-ring for 1-1/2" & 2" clean out plug
5	LS150G	5.55	2" o-ring; EPDM
5	LS150GV	13.86	2" o-ring; viton
6	LS212SS	66.80	12 mesh for 2" Y strainers; 316ss
6	LS220SS	66.80	20 mesh for 2" Y strainers; 316ss
6	LS230SS	66.80	30 mesh for 2" Y strainers; 316ss
6	LS250SS	66.80	50 mesh for 2" Y strainers; 316ss
6	LS280SS	66.80	80 mesh for 2" strainers; 316ss
KIT	MLS200BC	78.55	2" manifold Y strainer kit includes 1-5
KIT	MLS220BC	86.41	2" FP manifold Y strainer kit includes 1-5

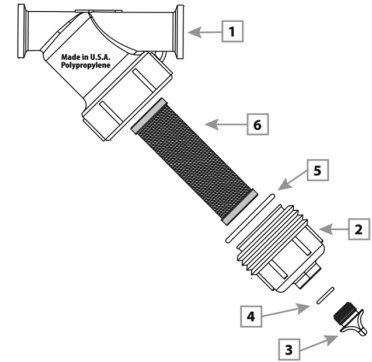

Manifold Flange T Strainer

- Heavy duty glass reinforced polypropylene • Clean out plug • EPDM gaskets; Viton available



Part #	Price Each	Description
MLST10030	\$68.18	1" female NPT; manifold T strainer; 30 mesh ss screen
MLST10050	68.18	1" female NPT; manifold T strainer; 50 mesh ss screen
MLST10080	68.18	1" female NPT; manifold T strainer; 80 mesh ss screen
MLST100100	68.18	1" female NPT; manifold T strainer; 100 mesh ss screen
MLST15030	118.07	2" female NPT; manifold T strainer; 30 mesh ss screen
MLST15050	118.07	2" female NPT; manifold T strainer; 50 mesh ss screen
MLST15080	118.07	2" female NPT; manifold T strainer; 80 mesh ss screen
MLST150100	118.07	2" female NPT; manifold T strainer; 100 mesh ss screen

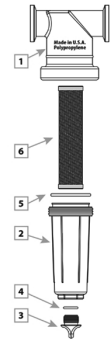

Replacement Parts For: 2" Manifold Flange T Strainer

Item	Part #	\$ Each	Description
1	MLST100H	\$24.40	1" T strainer body
1	MLST150H	47.40	1-1/2" T strainer body
2	LST100B	22.72	1" T bowl (contains #1 #2 #3 #4)
2	LST150B	40.97	1-1/2" T bowl (#1 #2 #3 #4)
3	LSP050	4.16	1/2" clean out plug
3	LSP100	4.99	1" clean out plug
4	LSP050G	1.38	EPDM o-ring for 1/2" clean out plug
4	LSP050GV	2.28	Viton o-ring for 1/2" clean out plug
4	LSP100G	1.50	EPDM o-ring for 1" clean out plug
4	LSP100GV	2.55	Viton o-ring for 1" clean out plug
5	LST100G	5.55	1" o-ring; EPDM
5	LST100GV	10.54	1" o-ring; viton

Item	Part #	\$ Each	Description
5	LST150G	\$5.55	1-1/2" o-ring; EPDM
5	LST150GV	13.86	1-1/2" o-ring; Viton
6	LST130SS	29.37	30 mesh for 1" strainer; 316ss
6	LST1530SS	49.01	30 mesh for 1-1/2" T strainer; 316ss
6	LST150SS	29.37	50 mesh for 1" T strainer; 316ss
6	LST1550SS	49.01	50 mesh for 1-1/2" T strainer; 316ss
6	LST180SS	29.37	80 mesh for 1" T strainer; 316ss
6	LST1580SS	49.01	80 mesh for 1-1/2" T strainer; 316ss
6	LST1100SS	31.54	100 mesh for 1" T strainer; 316ss
6	LST15100SS	49.01	100 mesh for 1-1/2" T strainer; 316ss
KIT	MLST100HB	43.79	1" manifold T strainer kit includes 1-5
KIT	MLST150HB	83.98	1-1/2" manifold T strainer kit includes 1-5

HANDGUNS

Spraying Systems

Heavy duty trigger operated handgun



Model	PSI	Barrel	Price
43H Brass	800	22	\$211.50
43HA Brass	800	13	192.00
43L Brass	200	22	211.50
43LA Brass	200	13	192.00
43H-AL	800	22	175.80
43HA-AL	800	13	168.40
43L-AL	200	22	175.80
43LA-AL	200	13	168.40
CP 4743-NY Gasket			2.00
D-orifice ~ D-2,4,5,6,7,10,12,16			2.00
DX-HSS long distance tips ~ D8, 10			30.90
PK-AB43 Kit			48.90
PK-AB43AL Kit			48.90

Econo-Gun



- Polypropylene body • Stainless steel spring • Viton rubber parts
- Viton pin bushing • On/off gun
- 150 psi max • 40 gpm

506532	Gun, 1/2" HB connection	\$48.00
506530	Gun, 3/4" HB connection	48.00
506531	Gun, 1" HB connection	48.00

Turbo Industrial Handgun

\$169.00



- 8" barrel
- 1/2" inlet with swivel
- Adjustable spray pattern

Adjustable Pattern Long Range Handgun

Spray patterns range from straight stream to cone mist by moving forward hand grip, up to 850 PSI with 1/2" MPT.



13.901.151	21" long, 30 gpm	\$298.00
7.901.03	17" long handgun	205.00
10/11	Repair kit	30.40
Optional	Size 1.5 to 3.0	17.40
tips	Size 3.5 to 7.0	28.90

Lesco Handgun, Kits, Replacement Nozzles



Handgun without tip - \$98.70*
 Repair kit, 7402 - \$22.40*
 Nozzles - \$7.90* ea (1.5, 2, 3, 4 gpm)

"Black Jewel" Spray Gun by Warne Companies



Premium quality, commercial handgun. Adjusts from mist to long range with a selection of nozzle sizes available. Use for lawn maintenance, tree and ornamentals, pest control, noxious weeds and fighting fire. Repair parts available. Major components from JD9 will interchange with the Black Jewel.

Part #	Description	Price
WCBJ	Spray gun	\$132.00
SG-PC-025-R1-Kit	Repair kit	17.84
BJ-PC-Nozzle Kit	Nozzle holder kit	16.50
SG-PCN-008	#8 nozzle	11.50
SG-PCN-015	1.5 nozzle	11.50
SG-PCN-025	2.5 nozzle, standard	11.50
SC-PCN-030	3.0 nozzle	11.50
SC-PCN-040	4.0 nozzle	11.50

Spraying Systems Gun \$122.70



Designed specifically for lawn care application of chemicals. Made of Deinn nylon. Only four moving parts. 3/4" inlet pipe thread with 1/2" hose barb insert with standard black nozzle, 3 gpm at 15-25 psi.

25990-3/4" Hose shank swivel \$16.42
 Optional nozzle \$17.40

Model Number	Nozzle Tip Number	Nozzle Tip Color	Capacity (GPM) at Various Pressures							
25660-1.5	25670-1.5-NY	Gray	1.4	1.9	2.3	2.6	2.9	3.4	4.0	
25660-3.0	25670-3.0-NY	Black	2.0	2.7	3.2	3.6	4.1	4.9	5.6	
25660-4.0	25670-4.0-NY	Red	2.3	3.1	3.7	4.3	4.7	5.6	6.4	

GNC 2000 Lawn Care Applicator Handgun



Durable nylon body. Available with three different nozzle volumes and hanger.

Handgun with 3 tips - \$95.32
 Nozzles - \$16.40 each (choice of 2, 3 or 4 gpm)
 Repair Kit - \$25.77 Trigger - \$16.42

Hand Boom Assy

WC-HBA \$168.00 each



Designed to save time and conserve product. Accurately apply fluid with a consistent spray pattern. Great for efficiently applying pesticides, fertilizers, soaps, sealants, and deicing brines. Available with trigger valve or thumb operated on/off.

Green Garde Spray Gun



Rugged and built to last!

Easily adjust from mist to long distant stream. Great performer with pressure up to 1,000 psi. Use for lawn maintenance, trees and ornamentals, pest control and noxious weed control.

Part #	Description	Price
38500	JD9-C spray gun	\$228.00
38507	JD9-PT (trigger control pattern)	234.00
3863*	All flooding nozzles	38.50
38602	Tip, L	20.50
38603	Tip, XL	20.50
38604	Tip, M	20.50
38605	Tip, S	20.50
38606	Tip, XS	20.50
38510	Repair kit, 101C	16.95
38511	Repair kit, 101TV	31.10
38516	Cap	13.00
38517	O-ring	2.00
38518	Whirler	33.85
38525	Teflon valve seat	20.50
38527	Valve spring	12.00
38528	Valve, stainless steel	59.50
38531	Trigger assembly	38.50
38533	Stopper clip	1.20
38534	Barrel adjust nut	59.00
38535	Screw	.96
38536	Gland	20.00
38538	Nut, stainless steel	.96
38539	Nut, locking	5.25
38540	Adapter, GHT	34.50
38543	Washer, GH leather	5.10

Handgun Mounts

Heavy duty. Can also be used for shovels, etc



1001 HookLok

Perfect for holding many handguns. Grip range 1" to 1-1/4".
 Package of two - \$26.90*

1004 HandleLok

Adjustable lock securing a wider variety of sizes. \$49.25*



1005 Flex Mount

Lock mount with strap. Grip range 1" to 1.75". \$63.66 each*



HANDGUNS Continued

Trigger Valve Handgun

Premium handgun for 12-volt sprayers. Adjustable nozzle. 3/8" hose barb. 

WCH-8	8" wand	\$62.50	Replacement trigger valve	\$25.70
WCH-18	18" wand	66.50	Replacement poly adjustable tip X8-X18	12.50
WCH-8-B	8" wand, brass nozzle	74.20	Replacement brass adjustable tip X16	24.20
WCH-18-B	18" wand, brass nozzle	78.20	Replacement brass adjustable tip X18	
50626600.152	3/8" hose barb	2.50	for Jackrabbits	24.20
50626600.153	1/2" hose barb	2.50	Replacement 8" brass barrel	14.90
5062600.150	1/2" poly MPT	2.50	Replacement 18" brass barrel	18.90
5062400.101	1/2" brass MP	11.00		

Aluminum Barrel Handgun

21", 3/8" inlet barb, X26 adjustable tip
50800-21-AL-406-X26
\$29.68

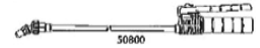

Replacement Adjustable Poly ConeJet Tips

38720-PB-X18 Orange
38720-PB-X26 Blue
\$11.25 each



Economy Spray Gun

SG-4507 \$19.30

#18 orifice for 12-volt sprayer

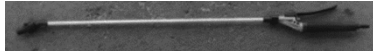

12-Volt Deluxe Sprayer Handgun

• All metal • Trigger guard • Adjustable brass tip
WCHD, 8" wand - \$104.00
WCHD, 18" wand - \$112.00
Metal trigger valve only - \$76.00



COUPLERS AND SWIVELS

CHAIN COUPLER

For coupling engine directly to pump. Hub size 1", 15/16", 3/4", 5/8" (specify each side when ordering). Double chain coupling.
\$145.00 per set



Coupler Male NPT	
38MS 3/8" Socket	\$27.80
50MS 1/2" Socket	30.50
75MS 3/4" Socket	67.20

QUICK COUPLER – OPEN BORE TYPE

Brass. For use with spraying equipment. Does not rust. Steel plugs. 

Coupler Female NPT	
38FS 3/8" Socket	\$27.80
50FS 1/2" Socket	30.50
75FS 3/4" Socket	67.20

Plugs, Female Thread	
38FPB 3/8" Plug	\$13.40
50FPB 1/2" Plug	17.00
75FPB 3/4" Plug	21.00

Plugs, Male Thread	
38MPB 3/8" Plug	\$ 8.60
50MPB 1/2" Plug	13.05
75MPB 3/4" Plug	14.00

HOSE AND TUBING CUTTERS

Light weight. Strong nylon handle. Will not distort pipe. Li'l Nipper cuts all sizes up to 1-1/4" polyethylene, PVC, ABS, and rubber hose. Big Nipper cuts hose and tubing up to 2-1/2" ID and PVC up to 1-1/2" ID.



0125	Li'l Nipper	\$14.25
0127	Replacement Blades (2-pk)	8.70
16368	Big Nipper	16.30

HANDGUN SWIVELS

Allows handgun to swivel independently of hose.

Part #	Description	PSI	Price
7016.00	1/2" MPT x 1/2" HB, SS	350	\$34.80
7016.005	1/2" MPT x 1/2" HB, SS	350	34.80
7016.01	1/2" MPT x 3/8" HB, pom resin	350	34.80
7016.02	3/4" MPT x 1/2" HB, pom resin	350	34.80
7016.GHT-06	MGHT x 3/8" HB, pom resin	350	34.80
8F8M	1/2" MPT x FPT, Brass	1000	36.00
6F6M	3/8" MPT x FPT, Brass	1000	36.00



GAUGES

Liquid Filled, Rear Mount Stainless Steel Gauges

2241GXB60	0 – 60 psi	\$26.80
2241GXB100	0 – 100 psi	26.80
2241GXB200	0 – 200 psi	26.80
2241GXB400	0 – 400 psi	26.80



Liquid Filled Stainless Steel Gauges

2141GXB060	0 – 60 psi	\$26.80
2141GXB100	0 – 100 psi	26.80
2141GXB200	0 – 200 psi	26.80
2141GXB300	0 – 300 psi	26.80
2141GXB400	0 – 400 psi	26.80
2141GXB600	0 – 600 psi	26.80
2141GXB1000	0 – 1000 psi	26.80



4" Liquid Filled Gauges, 1/4" Bottom Stem

4140GXB60	SG-4-60 psi	\$48.10
4140GXB100	SG-4-100 psi	48.10
4140GXB200	SG-4-200 psi	48.10



Pressure Gauge Protector

2300	Gauge isolator kit for 1/4" and 1/8" line	\$119.45
1181	1/8" Tube fitting	5.20
1182	1/8" Tube union	7.60
045 2404047	Gauge dampener	8.95



UDOR Gauges

GG 1000	Bottom stem	0 – 1000 psi	\$ 39.90
GG 1000BM	Back mount	0 – 1000 psi	39.90
GG 350	Bottom stem	0 – 350 psi	39.90
GG 350BM	Back mount	0 – 350 psi	39.90



VALVES

BRASS BALL VALVES - 600 PSI

943202	1/2"	\$24.40
943203	3/4"	39.40
943204	1"	64.21
943205	1-1/4"	101.50
943206	1-1/2"	161.96
943207	2"	195.54



STAINLESS STEEL VALVES (316)

Full port, 1000 psi, heavy wall

949171	1/4"	\$36.08
949172	3/8"	36.16
949173	1/2"	51.38
949174	3/4"	79.00
949175	1"	99.14
949176	1-1/4"	143.66
949177	1-1/2"	178.30
949178	2"	229.41



1999A ELECTRIC SOLENOID VALVE

12-volt, 1" inlet, 3/4" outlet, up to 175 psi valve

1999A	Spade	\$190.00
1999A-WP	Weather pack	190.00
1988	Single mounting bracket	36.00
1990	Triple mounting bracket	56.00
2515	Coil assembly (spade)	98.45
2517	Repair kit	72.30
2520	Coil assembly (weather pack)	99.90
WPADAP	Weather pack adapter for solenoids	9.20



UDOR HIGH PRESSURE BALL VALVES

700 PSI 3/8" MBSPT x 1/2" MBSPT

Premium Valve (Can be used for pressure adjustment)

0608.45	Right hand ball valve	\$56.50
0608.46	Left hand ball valve	56.50



SPRAYING SYSTEMS ELECTRIC BALL VALVES

1" inlet and 1" outlet

Single Valve

344BEC-24C	\$399.00
344BEC-2F-C flange	399.00
2 Valve Manifold	
442BEC-44T-C	\$ 924.00
452BEC-2F-C flange	856.00
3 Valve Manifold	
443BEC-44TA	\$1,376.00
453BEC-2F-C flange	1,274.00

- Replacement electric pigtail 98-546EC.15 \$28.14
- Replacement motor for valves at left. 50515-22CP05 \$337.95
- Repair kit AB344AE-Kit \$79.00
- 2" inlet and 2" outlet single electric ball valve 084063185 Banjo \$696.00



2502B ELECTRIC SOLENOID VALVE

25021B-WP	Single solenoid (weather pack)	\$144.00
CL.2641.WP	Replacement coil (weather pack)	130.10
KT.2352	Repair kit	37.75
BK.2148	Single mounting bracket	30.64
BK.2149	Bank of 2 mounting brackets	38.30
BK.2151	Bank of 3 mounting brackets	44.60



2100C AND 2500 ELECTRIC SOLENOID REPAIR PARTS

CL.2831	2100C replacement coil (spade)	\$108.10
CL.2845	2100C replacement coil (weather pack)	109.28
CL.2642	2500 replacement coil (spade)	112.80
CL.2641	2500 replacement coil (weather pack)	130.10
KT.2352	2100 and 2500 repair kit	37.75
WPADAP	Weather pack adapter for solenoids	9.20
	Other parts available - inquire	

PLUNGER VALVES FOR POSITIVE SHUTOFF

Side inlet, bottom outlet, 75-series flange inlets. Maximum pressure 175 psi. Mounting brackets. 541EC-2 Single \$368.00 each 543EC-2 Triple \$1,131.00 each



SPRAYING SYSTEMS SOLENOID VALVES

Spraying Systems 144 Series 12-volt DC direct to valves for remote electric on-off control of boom or nozzles lines. Internal parts are stainless steel with chemically resistant rubber seat washer and diaphragms. Operating pressure range is 0-65 psi. Coil has 1/4" male quick connect terminals for electric power connecting. Valves normally closed, open when coil is energized.



AA144A-1	One valve unit, 3/4" x 1/2"	\$201.50
AA144A-3	Three valve unit, 3/4" x 1/2"	615.00
AA144F-1-3	Three way (foam marker), 50 psi	225.80
PK-AB144-1-Kit	Repair kit	41.50
PK-AB144-1-3-Kit	3-way repair kit	41.60

2500 SOLENOID VALVE WITH TIR E-CHIP

Requires 66% less normal amperage requirements. 3/4" inlet, 1/2" outlet, 100 psi operating pressure, 10 gpm, viton seal on o-rings. Use on units where less amperage is required. Weather pack standard.

SV.2500B.1WP.C	Valve	\$205.70
CL.2641.WP.C	E-chip coil	131.10



BANJO 1/2" MOTORIZED BALL VALVE

- 1/2" ports • 12-volt DC • Response time: 1/3 seconds open to close • Standard 3 wire configuration • Max pressure 200 psi @ 70°F LEV050 - \$153.00



BRASS HIGH PRESSURE VALVE

1/2" Inlet, 1/2" outlet. Excellent replacement valve for root feeders.

305A-4-1	Valve	\$192.00
305A-4-Kits	Repair kit	37.00
305A-410-1	Lever	33.70
305A	Squeeze lever / bracket assembly	39.70



MANUAL SOLENOID VALVE

AA6B MANUAL VALVE

AA6B	Manual valve, 1/2" FPT	\$66.30
CP36301NY	Replacement handle	7.50
CP36308-SS	Replacement pin	1.80



8-WAY SELECTOR VALVE

AA17L	8-way selector valve	\$168.40
PK-AB17-Kit	Repair kit	61.80



1" 45° NOZZLE FP

SU100FP-NOZ \$32.30



PRESSURE REGULATOR

Pressure regulator electric bypass valve

- Model 1560 3/4" MPT, up to 50 gpm \$180.30
- Model 1541 1" MPT, up to 100 gpm \$207.00
- Spraying Systems AA244C3/4" \$191.00



3-WAY SOLENOID VALVE

1/4" NPT inlet and two each 1/4" NPT outlets. Ideal valve for foam marker.

2204A \$122.50



VALVES

TOPAZ FLOAT VALVE

TPV0100DLT \$127.00



Float operated valve for use in automatic filling of water storage tanks and troughs. Valve detaches with 1/4-turn for ease of cleaning.

ONE PIECE ALL BRASS VALVE

Chrome brass ball, stem, and body with Teflon seat and viton seals. Rated to 300 psi. Maximum temperature 212°F. Available with two female ports or one female and one male port. All ports are NPT.

46922I	1/4" FXF	\$21.50
46903I	1/4" MXF	20.95
46923I	3/8" FXF	21.50
46904I	3/8" MXF	20.95
46924I	1/2" FXF	24.80
46905I	1/2" MXF	23.30



VALVE MOUNTING PLATE

V2571 90° mounting bracket \$29.13
Fits valves 1-1/4" to 2"



V25270 Straight mounting bracket \$28.43
Fits valves 1-1/4" to 2"

VALVE CARRY HANDLE

V25272 Valve handle \$40.63
316 SS fits most bolted valves
1-1/4" full port and larger



PRESSURE RELIEF VALVES

1/4" ports for gauge pressures to 150 psi

23120-3/4 3/4" outlet \$43.20

23120-1/2 1/2" outlet \$43.20



Up to 300 psi

8460 3/4" nylon with 1/4" gauge fitting \$79.25

8460 1/2" nylon with 1/4" gauge fitting \$79.25

HAMILTON BALL TYPE RELIEF VALVES

Pressure relief valve models for pressures to 400 psi. Choice of 1/2" or 3/4" pipe thread connections (male NPT inlet, female NPT outlet).



3300-0002 1/2" x 1/2" brass relive valve, 200 psi \$98.60

3300-0001 3/4" x 3/4" brass relief valve, 400 psi \$109.20

3-WAY BALL VALVE – FULL PORT

1/2 turn, true 3-way valve.
Arrow indicates direction of flow.



SU050BL	1/2"	\$35.73	SU125BL	1-1/4"	\$57.75
SU075BL	3/4"	40.45	SU150BL	1-1/2"	67.75
SU100BL	1"	40.73	SU200BL	2"	84.42

CHECK VALVE (PVC)

Use this valve in any industrial or agricultural application to stop backflow and syphoning, including on potable water lines.



CV12	1/2"	\$10.37
CV34	3/4"	10.75
CV100	1"	15.65
CV112	1-1/2"	21.75
CV114	1-1/4"	19.70
CV200	2"	27.00

1/2" and 3/4" DIAPHRAGM CHECK VALVES

Use on boomless nozzle assemblies

12328-1/2" NYB \$112.98

12328-3/4" NYB \$112.98



THROTTLING VALVE

Polypropylene construction for excellent chemical resistance. 1/2" and 3/4" NPT connections. Pressures to 150 psi. 10 psi pressure drop at 6 gpm flow rate for 1/2", 18 gpm for 3/4" size.

23520-1/2 PP ~ \$37.40 235250-3/4 PP ~ \$38.40



3/4" NYLON THROTTLING VALVE

12690-3/4 NYB \$116.50

NPT connections. Pressures to 125 psi. Nylon. Maximum flow rate at 100 psi, 56 gpm for 1/2" and 82 gpm for 3/4" size.



SINGLE UNION POLY BALL VALVES

SU050E	1/2"	\$22.42
SU075E	3/4"	22.42
SU100E	1"	27.10
SU125E	1-1/4"	46.60
SU150E	1-1/2"	47.83
SU200E	2"	60.58

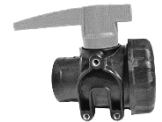

BOLTED BALL VALVES

V050FPY	1/2"	\$43.87
V075FPY	3/4"	43.87
V100Y	1"	43.87
V100FPY	1", full port	48.37
V125Y	1-1/4"	48.37
V150FPY	1-1/2"	60.22
V200Y	2"	60.22



6-BOLT BALL VALVE WITH STAINLESS STEEL BOLTS

For fertilizer. Standard port valves.

V200FPY	2", full port	\$84.80
V300Y	3"	136.35
V300FPY	3", full port	189.35



BOLTED POLY NOZZLE VALVES

VA200FP	2"	\$118.33
---------	----	----------



TWO WAY FGHT VALVE

All ports feature 3/4" garden hose thread. Valves are suitable for unidirectional flow only and are not recommended for commercial use.



30631	3/4" FGHT (inlet) x 3/4" MGHT (Straight)	\$7.25
30626	FGHT x MGHT x MGHT (Y)	10.15

COMPACT POLYPROPYLENE BOLTED BALL VALVES

Male pipe thread x male camloc
VF204FPY 2" \$80.50



HOSE

PVC CLEAR SIGHT GAUGE

Part #	Size	PSI	\$/Ft
SGH038	3/8"	30	\$0.98
SGH050	1/2"	30	1.37
SGH058	5/8"	30	1.66
SGH075	3/4"	30	1.77
SGH100	1"	30	2.86

GAUGE TUBING

TBG2388 1/8" x 25' \$64.00

PVC LAY FLAT DISCHARGE HOSE, BLUE

13026505	1-1/2"	75	\$1.11
13027005	2"	70	1.30

TUBING

Polyethylene Drill & Planter Tubing, Black or Gray

Part #	Description	Qty	Ft \$	Roll \$
46428	3/16" x 1/4" OD coil	100' roll	\$1.25	\$112.50
46434	1/4" ID x 3/8" OD coil	100' roll	\$1.95	\$175.50

TRANSLUCENT SPRAY HOSE

EVA ANHYDROUS AMMONIA AND SPRAYER

Part #	Size	\$/Ft	Less 10% on full rolls	Part#	Size	\$/Ft
EVA025	1/4"	\$0.58		EVA058	5/8"	\$1.12
EVA038	3/8"	0.80		EVA075	3/4"	1.38
EVA050	1/2"	0.98		EVA100	1"	1.92

RUBBER GENERAL PURPOSE SPRAY HOSE

Part #	Size ID	PSI	\$/Ft
RSH025	1/4"	200	\$ 0.87
RSH038	3/8"	200	0.97
RSH050	1/2"	200	1.35
RSH058	5/8"	200	1.86
RSH075	3/4"	200	2.05
RSH100	1"	200	3.20
RSH125	1-1/4"	200	5.37
RWS150	1-1/2"	200	6.90
RWS200	2"	150	9.08

"RED SLIDER" HOSE FOR REMOTE CONTROL HOSE REELS

3/8" ID, 1/2" OD, 1000 psi BP, slick'em type hose. For Hannay, Intella Spray, and other standard hose reels. Easy to pull through the weeds. Hose length includes brass ends. Specify MPT size of 1/2" or 3/8".

100' length - \$281.25 600' length - \$1,560.00
300' length - \$806.25 Custom cut - \$2.95/ft

SUCTION HOSE WITH GREEN PVC HELIX

Extra flexible. Recommend suction hose for diaphragm and other positive displacement pumps. 100' rolls.

Part #	Size ID	\$/100' Roll	\$/Ft Cut Length
K075	3/4"	\$ 179.00	\$ 1.99
K100	1"	216.00	2.40
K125	1-1/4"	241.00	2.68
K150	1-1/2"	320.00	3.56
K200	2"	448.00	4.98

GREEN PVC WATER SUCTION & TRANSFER HOSE

Part #	Size	PSI	\$/Ft*
PVC100, green	1"	90	\$ 2.02
PVC125, green	1-1/4"	70	2.20
PVC150, green	1-1/2"	70	2.73
PVC200, green	2"	60	4.90

FERTILIZER EPDM

Suction and Transfer Bumble Bee Hose, 100' Rolls

Part #	Size	PSI	\$/Ft/Roll	\$/Less than 25'*
EPDM100	1"	80	\$ 3.44	\$ 3.82
EPDM125	1-1/4"	70	3.91	4.34
EPDM150	1-1/2"	60	4.12	4.58
EPDM200	2"	60	5.93	6.59
EPDM300	3"	50	11.30	12.56

ENFORCER REINFORCED FERTILIZER SOLUTION HOSE, 100' ROLL

Part #	Size	PSI	\$/Ft	\$/Less than 25'*
12012964	2"	100	\$ 8.04	\$ 8.93
12012966	3"	85	13.82	15.35

AIR SEEDER HOSE (Braided and Clear)

Part #	Size	\$/Cut Length	\$/100' Roll*
12015003	1"	\$ 1.95	\$ 176.50
12017507	2-1/2"	7.25	653.00

* Less 10% on full rolls



GREEN GARDE HEAVY DUTY TREE SPRAYER HOSE

- Heavy-duty spray hose • 5-ply banded construction
- Superb abrasion resistance • Long lasting flexibility
- Resistant to fungicides, insecticides, and fertilizer

Part #	Size	PSI	Roll Size	Color	\$/Ft Cut	\$/Ft Uncut
BNG-43	1/2"	800	300'	Neon	\$ 4.69	\$ 4.36

KURI TEC HIGH PRESSURE HOSE

Part #	Size	PSI	Roll Size	Color	\$/Ft Cut	\$/Ft Uncut
K4131	3/8"	600	300'/400'	Blue/yellow	\$ 1.25	\$ 1.15
K4131	1/2"	600	300'/400'	Blue/yellow	1.85	1.75

Part #	Size	PSI	Roll Size	Color	\$/Ft Cut	\$/Ft Uncut
A1687-08	1/2"	800	300'/400'	Green	\$ 3.96	\$ 3.66
A1687-10	5/8"	800	300'	Green	4.72	4.42
A1687-12	3/4"	800	300'	Green	6.00	5.80

High pressure fittings and banding available

KURI TEC EVA YARN REINFORCED HOSE FOOD GRADE, HEAVY WALL

Part #	Size	PSI	Roll Size	\$/Ft
K4350-08	1/2"	250	300'	\$1.51
K4350-12	3/4"	150	300'	2.26
K4350-16	1"	150	200'	3.92

HOSE BEND RESTRICTORS

HBR-0081	5/8"	\$9.25
HBR-1052	1/2" thick wall	\$7.25
HBR-1054	1/2"	\$7.25
HBR-1050	3/8" thick wall	\$7.25
HBR-1055	3/8"	\$7.25



HEAVY DUTY SLINKY HOSE FOR ATV SPRAYERS

HSC 2846-06X15CN \$63.00

Pesticide resistant hose with brass 3/8" MPT fittings. 15' 3/8" ID

HOSE REELS AND ACCESSORIES

COXREEL HOSE REELS

Manual Reels - Pressures to 3000 PSI, Commercial Use

Part #	Reel Capacity, Swivel	Price
112-4-75 KVXX	75' of 1/2" hose, Brass Swivel	\$260.00
HP1125-4-200 KVXX	200' of 1/2" hose, Super Swivel	371.00
HP1125-4-325 KVXX	300' of 1/2" hose, Super Swivel	389.00
HP1125-5-100KVXX	100' of 3/4" hose, Super Swivel	565.00
HP1125-5-200KVXX	200' of 3/4" hose, Super Swivel	575.00
HP1125-5-250 KVXX	250' of 3/4" hose, Super Swivel	579.00
HP1175-6-150 KVXX	150' of 1" hose, Super Swivel	784.00

12-Volt Electric Reels - Commercial Use

Part #	Reel Capacity, Swivel	Price
HP1125-4-200E KVXX	200' of 1/2" hose, Super Swivel	863.00
HP1125-4-325E KVXX	300' of 1/2" hose, Super Swivel	883.00
HP1125-4-450E KVXX	400' of 1/2" hose, Super Swivel	922.00
HP1125-5-100E KVXX	100' of 3/4" hose, Super Swivel	\$940.00
HP1125-5-200E KVXX	200' of 3/4" hose, Super Swivel	976.00
HP1125-5-250E KVXX	250' of 3/4" hose, Super Swivel	998.00
HP1175-6-100E KVXX	100' of 1" hose, Super Swivel	1,325.00
HP1175-6-125E KVXX	125' of 1" hose, Super Swivel	1,345.00
HP1175-6-150E KVXX	150' of 1" hose, Super Swivel	1,345.00

Part #	Description	Price
7408-12-1/2"	Axle plumbing for 1125-4-200	\$ 76.00
7408-18-1/2"	Axle plumbing for 1125-4-325	79.00
7414-12	Drum for 1125-4-200	51.50
7414-18	Drum for 1125-4-325	57.80
7414-24	Drum for 1125-4-450	62.10
7414-28	Drum for 1125-5-250	73.68
7416	Disc end plate 17.5"	65.30
7425	Pinon drive gear	59.40
7450	Disc end plate 17.5" with gear	137.60
7480	Stack kit for staking reels (bottom reel drum width)	151.00
15353	4-way roller assembly x hose reel widths	228.00
	Above installed (must have reel model)	241.00
9075-12.5	KXXX 4-way roller to fit 112-4-75	178.50
20843	Hose reel pin lock	24.70
24106	Solenoid for 12-volt reels	47.50
90030	Push button switch	19.40
	Replacement motor for Coxreel	392.00
	25' power lead with 30-amp breaker	95.00
20649	1/2" reel bearing	18.20
15515	3/4" reel bearing	23.00

REELCRAFT HOSE REELS

Part #	Description	Price
CH37118L	100' of 1" hose, manual	\$775.00
EH37118L	100' of 1" hose, 12-volt	1,290.00

HANNAY HOSE REELS



Model	Reel Capacity	Price
PW-2 w/roller guide	75' of 1/2" hose	\$341.00
1520-17-18, manual	200' of 1/2" hose	408.00
1520-17-18, electric	200' of 1/2" hose	985.00
1526-17-18, manual	300' of 1/2" hose	408.00
1526-17-18, electric	300' of 1/2" hose	985.00
1530-17-18, electric	400' of 1/2" hose	985.00
1830-17-18, electric	250' of 5/8" hose	1,085.00
1836-17-18, electric	300' of 5/8" hose	1,095.00

Above equipped with Super Swivel, switch, and solenoid

Part #	Description	Price
9910.1119	Replacement drive sprocket	\$ 32.90
9915.0042	Replacement electric motor	392.00
9923.0006	Motor mounting plate	30.60
9939.1062	Roller assembly for Hannay Reels Must have reel model	308.00
	As above, installed	348.00
9965.0030	Hose reel pin lock	41.30

MINI HOSE REELS

Pesticide compatible hose reel with
50' of 3/8" or 1/2" hose capacity
CU8050, reel only - \$187.00



Low pressure, 12-volt centrifugal pumps
With 50' of 3/8" hose - \$265.00
With 50' of 1/2" hose - \$292.00

High pressure, steel banded ends, roller or
diaphragm pumps
With 50' of 3/8" hose - \$304.00
With 50' of 1/2" hose - \$337.00

112-4-75 Cox Reel	High Pressure	Low Pressure
With 100' of 1/2" hose	\$495.00	\$419.00
With 100' of 3/8" hose	\$465.00	\$364.00

REPLACEMENT HOSE REEL SWIVELS



Super Swivel - Greaseable, 3000 psi working
pressure, compatible with fertilizer and pesticide

Reel Size	Part #	Price	Repair Kit #	Price
1/2"	9927.8551	\$ 86.00	SS8-Kit	\$21.90
3/4"	9928.8551	115.00	SS12-Kit	23.52
1"	9909.8551	141.00	SS16-Kit	25.90

Reelcraft Swivel

Reel Size	Part #	Price
1/2" Brass	S602096-1	\$35.20

This swivel is
not repairable

HYPRO PUMPS

Roller Pumps

Model Number	Max GPM	Max PSI	Max RPM	Description	Price
6500C	22.0	300	1200	Cast iron 6-roller pump, nylon rollers, viton seals, 3/4" NPT ports and 5/8" solid shaft	\$226.00
6500CR	22.0	300	1200	Reverse rotation for engine mount	239.00
6500XL	22.0	300	1200	Silver cast 6-roller pump, super rollers, viton seals, 3/4" NPT ports and 5/8" solid shaft	716.90
6500XLR	22.0	300	1200	Reverse rotation for engine mount	725.00
7560C	22.0	300	1200	Cast iron 8-roller pump, nylon rollers, viton seals, 3/4" NPT ports and 15/16" solid shaft	272.90
7560CR	22.0	300	1200	Reverse rotation for engine mount	305.00
7560XL	22.0	300	1200	Silver cast 8-roller pump, super rollers	867.00
7560XLR	22.0	300	1200	Reverse rotation for engine mount	897.00
3430-0380				Repair kit for 6500 pump – rollers, o-ring, viton seal	55.01
3430-0381				Repair kit for 7560 pump – rollers, o-ring, viton seal	78.74
3420-0023				Base kit for mounting to 6500 engines	45.92
3420-0003				Base kit for mounting to 7560 engines	71.90
BAC-10-RP6-QC				PTO coupler multi speed 540/1000 by 5/8	68.60
BAC-10-RP8-QC				PTO coupler multi speed 540/1000 by 15/16	68.60
RP-TBK				Torque bar and chain	38.10

Series 4001 and 4101 Roller Pumps

Model Number	Max GPM	Max PSI	Max RPM	Description	Price
4001C	9.1	150	1800	Cast iron 4-roller pump, polypropylene rollers, viton seals, 3/4" NPT ports, 5/8" solid shaft	\$255.36
4001XL	9.1	150	1800	Silver cast 4-roller pump, super rollers, viton seals, 3/4" NPT ports, 5/8" solid shaft	641.76
4101C	7.2	150	2600	Cast iron 4-roller pump, polypropylene rollers, viton seals, 3/4" NPT ports, 5/8" solid shaft	241.00
4101XL	7.2	150	2600	Silver cast 4-roller pump, super rollers, viton seals, 3/4" NPT ports and 5/8" solid shaft	649.00
4101XL-EH	7.5	50	1900	12V DC motor driven Ni-resist 4-roller pump, polypropylene rollers, viton seals, 3/4" ports, 1/2" hollow shaft	930.00
1320-0015				Shaft coupler 3/4" x 5/8"	51.52
1320-0016				Shaft coupler 5/8" x 5/8"	51.52
3430-0390				Repair kit for 4000 series poly rollers, o-ring, viton seal	46.70
2840-0084				Pump support/coupler shield	62.00
				Chain coupler, must specify both shaft sizes	145.00

Series 9200 Pedestal Pumps

Model Number	Max GPM	Max PSI	Max RPM	Description	Price
9202C	105	180	6000	Pedestal mount cast iron, 5/8" solid shaft, viton shaft seal, 1-1/4" inlet, 1" outlet NPT ports	\$590.00
9203C	136	180	6000	Pedestal mount cast iron, 5/8" solid shaft, viton shaft seal, 1-1/2" inlet, 1-1/4" outlet NPT ports	598.00
1720-0083				O-ring	4.77
3430-0332				Viton seal kit for 9200, 9300, 9500	71.57
3430-0589				Life guard silicon carbide seal for 9200, 9300, 9500	277.76

Series 9300 Hydraulic Motor Driven Pumps

Model Number	Max GPM	Max PSI	Description	Price
9303C-HM1C	114	130	(10 gpm) Hydraulic motor/cast iron pump for open center systems, NPT ports: 1-1/2" inlet, 1-1/4" outlet	\$1,102.00
9303C-HM2C	82	95	(5 gpm) Hydraulic motor/cast iron pump for closed center systems, NPT ports: 1-1/2" inlet, 1-1/4" outlet	1,102.00
9303C-HM3C	106	85	(20 gpm) Hydraulic motor/cast iron pump for large open center systems, NPT ports: 1-1/2" inlet, 1-1/4" outlet	1,172.00
9303C-HM4C	95	93	(7 gpm) Hydraulic motor/cast iron pump for closed/open center systems, NPT ports: 1-1/2" inlet, 1-1/4" outlet	1,102.00
9303C-HM5C	147	145	(15 gpm) Hydraulic motor for Closed/open center system, NPT ports: 1-1/2" inlet, 1-1/4" outlet	1,102.00
9306C-HM1	207	130	(13 gpm) Hydraulic motor/cast iron pump for closed center systems, NPT port: 2" inlet, 1-1/2" outlet	1,278.50
9306C-HM5C	212	140	(17 gpm) Hydraulic motor/cast iron pump for closed/open center systems, NPT port: 2" inlet, 1-1/2" outlet	1,260.00
3430-0748			Hydraulic motor seal kit	64.70

Flange fitting housings available for retro fitting on pumps at no additional charge. Please request.

We also stock pump parts – please inquire

HYPRO / AR PUMPS

Series 9400 Belt Drive Centrifugal



Model Number	Max GPM	Max PSI	Max RPM	Description	Price
9402C-1000	76	96	1000	Cast iron pump with positive timing belt drive and 1-3/8" PTO shaft NPT ports: 1-1/4" inlet, 1" outlet	\$1,490.00
9402C-540Q	76	95	600	Cast iron pump with positive timing belt drive and 1-3/8" NPT ports: 1-1/4" inlet, 1" outlet	1,490.00

Medium Pressure Diaphragm



Model Number	Max GPM	Max PSI	Max RPM	Description	Price
AR30-SP (9910-D30)	9.5	580	550	2-Diaphragm pump – 1" HB inlet, 1/2" HB outlet	\$599.00
AR30-GR3/4-GCI (9910-D30GRGI)	9.5	580	550	2-Diaphragm pump – GS40GI control unit and gear reduction fits 5-6 hp gas engine	1,090.00
AR403-SP (9910-D403)	10.6	580	550	3-Diaphragm pump – 1" HB inlet, 1/2" HB outlet	787.00
AR403-GR3/4GCI (9910-D403GRGI)	10.6	580	550	3-Diaphragm pump – GR40 control unit and gear reduction that fits 5-6 hp gas engines	1,122.00
AR50-SP (9910-D50)	14.0	580	550	2-Diaphragm pump – 1-1/4" HB inlet, 1/2" HB outlet	1,048.00
AR503-SP (9910-503)	15.0	580	550	3-Diaphragm pump – 1/14" HB inlet, 3/4" NPT outlet; Select shaft kit or gear box	1,015.00
AR503-GR1-GCI (9910-D503GRGI)	15.0	580	550	3-Diaphragm pump, assembled with gear box 9910-KIT1642 and control 9910-RM40 for mounting on 8 hp gas engines	1,470.00
AR70BP-SP	19.6	290	550	2-Diaphragm pump – 1-1/4" HB inlet, 1" outlet	795.00
AR70BP-GR3/4	19.6	290	550	2-Diaphragm pump – 1-1/4" HB inlet, 1" outlet with gear box AR1671 for gas engine with 3/4" shaft; requires remote mount control unit (not included)	1,336.00

For high volume, high pressure pumps . . . call for a quote

Diaphragm Kits

Model Number	Description	Price
AR43243	Diaphragm Kit AR-70	\$101.40
AR43281 (9910 Kit 1723)	Diaphragm Kit D-252	67.60
AR43285 (9910 Kit 1724)	Diaphragm Kit D-30	82.65
AR43289 (9910 Kit 2423)	Diaphragm Kit D-303, D-403	75.00
AR43293 (9910 Kit 1725)	Diaphragm Kit D-50	86.73
AR43297 (9910 Kit 1986)	Diaphragm Kit D-503	123.50
650671 (9910-650670)	Damper D-30, D-50	21.10
9910 Kit 1721	Diaphragm Kit D-100	189.00

GS/GI Control Units and Repair Kits

Model Number	Description	Price
AR1925 (9910 Kit 1757)	Repair kit for 9910 GS GI	\$90.35
AR1990 (9910 Kit 1990)	D-252 control unit	141.00
AR2488 (9910 Kit 2488)	Repair kit for GR-40 control unit	48.00
AR43969 (9910 Kit 1897)	Repair kit for RM-40 control unit	75.75
AR8935 (9910 Kit 893)	Remote mount kit for GR-40 control unit	104.00
GI40 (9910-G540GI)	D-30, D-50 control unit	283.00
GR40 (9910-GR40)	D-303 and D-403 control unit	212.25
RM40S (9910-RM40)	D-503 control unit	232.00

Valve Kits

Model Number	Description	Price
AR1917 (9910 Kit 1917)	D-30 valve kit	\$159.00
AR1920 (9910 Kit 1920)	D-50 valve kit	164.00
AR1987 (9910 Kit 1987)	D-503 valve kit	217.00
AR2364	AR-70 BP valve kit	166.00
AR2388 (9910 Kit 2388)	D-303 and D-403 valve kit	163.50

Gear Reduction Units

Model Number	Description	Price
AR1636 (9910 Kit 1640)	D-30, D-303, D-403 gear reduction box	\$593.00
AR1639 (9910 Kit 1642)	D-50, D-503, D-813 gear reduction box	653.00

Miscellaneous Hypro Pump Parts







Part Number	Description	Price
110121	Relief valve seat (std)	\$9.27
390060	O-ring for suction manifold	2.15
450145	Discharge flange housing	46.32
620950	Gear box gasket	4.03
620101	D-30 RH head	159.00
620102	D-30 LH head	164.00
620150	D-30 suction manifold	124.00
629209	D-30 lower air chamber	264.00
629211	Upper air chamber	115.00
650101	D-50 RH head	190.72
650102	D-50 LH head	190.72
650150	D-50 suction manifold	145.00
651670	D-30 and D-50 dampener clamp	24.13
659204	D-50 complete lower air chamber	373.00
Kit1916	D-30 complete o-ring kit	64.17

Miscellaneous Hypro Pump Parts

Part Number	Description	Price
AR1919 (9910-Kit 1919)	D-50 complete o-ring kit	\$55.10
1040310	D-403 and D-503 oil sight glass	110.20
1040326	D-403 and D-503 oil tank cap	40.30
550030	D-30 oil sight glass	21.02
550040	D-30 and D-50 sight glass cap o-ring	2.32
550050	D-30 and D-50 sight glass cap	13.25
650030	D-50 oil sight glass	46.95
650230	D-50 upper air chamber	143.80
650920	D-403 and D-503 oil cap o-ring	3.42
801940	D-252 head	62.30
0152-9075C	Hypro 1551SP pump casing	1,661.00
0153-9200C	Hypro 1551 pump casing	509.00
0404-9200P	Hypro 1551 impeller	376.00
0707-9200C	Hypro 1551 flange bracket	415.30
1410-0091	Hypro 1551 slinger ring	5.51
1720-0180	Hypro 1551 case o-ring	5.35

UDOR KAPPA / DELTA Series Diaphragm Pumps

UDOR KAPPA-series internally manifolded pumps are of anodized aluminum construction



Model	Max GPM	Max PSI	Description	HB Port In	HB Port Out	By-pass	Wgt	Price
KAPPA-25-WOC 	7	350	Two-diaphragm pump with pulsation dampener, control unit, adjustable pressure regulator, manual dump valve, dual ball valve outlets, pressure gauge, mounting rails.	1"	0	0	16	\$685
KAPPA-25				1"	(2)	3/4"	18	898
KAPPA-25/GR	7	350	KAPPA-25 with gearbox for 3-5.5 hp gasoline engines, 3/4" shafts.	1"	(2)	3/4"	18	1,034
			6062.C1 Diaphragm kit					90.41
			8700.65CK Diaphragm kit with bolt, washer, valves, and o-rings					291.88
Model	Max GPM	Max PSI	Description	HB Port In	HB Port Out	By-pass	Wgt	Price
DELTA-40-WOC 	10.5	560	Two-diaphragm pump with universal drive face, pulsation dampener, control unit, adjustable pressure regulator, manual dump valve, dual ball valve outlets and pressure gauge.	1"	0	0	27	\$836
DELTA-40				1"	1/2"	3/4"	29	1042
DELTA-40/GR	10.5	560	KAPPA-40 with gear reduction for 5 hp engines.	1"	1/2"	3/4"	39	1,516
			8700.85 Diaphragm kit					97.50
			8700.85CK Diaphragm kit with bolt, washer, valves, and o-rings					292.00
Model	Max GPM	Max PSI	Description	HB Port In	HB Port Out	By-pass	Wgt	Price
KAPPA-43-WOC 	10.5	560	Three-diaphragm pump with control unit, adjustable pressure regulator, manual dump lever, dual ball valve outlets, pressure gauge.	1"	0	0	27	\$836
KAPPA-43				1"	2-1/2"	3/4"	29	1,043
KAPPA-43/GR	10.5	560	DELTA-43 with gear box for 4-6.5 hp gasoline engines, 3/4" shafts.	1"	2-1/2"	3/4"	39	1,516
			8700.45 Diaphragm kit					103.70
			8700.45CK Diaphragm kit with bolt, washer, valves, and o-rings					380.20
Model	Max GPM	Max PSI	Description	HB Port In	HB Port Out	By-pass	Wgt	Price
KAPPA-55-WOC 	15	560	Three-diaphragm pump with universal drive face, pulsation dampener, control unit, adjustable pressure regulator, manual dump valve, dual ball valve outlets, pressure gauge.	1-1/4"	0	0	35	\$1,169
KAPPA-55				1-1/4"	1/2"	3/4"	37	1,376
KAPPA-55/GR-5	15	350	KAPPA-55 with a gear reduction for 5-6.5 hp gasoline engines	1-1/4"	2-1/2"	3/4"	43	1,856
KAPPA-55/GR-8	15	560	KAPPA-55 with a gear reduction for 8-9 hp gasoline engines	1-1/4"	2-1/2"	3/4"	49	1,970
			8700.26 Diaphragm kit					108.00
			8700.26CK Diaphragm kit with bolt, washer, valves, and o-rings					409.55
Model	Max GPM	Max PSI	Description	HB Port In	HB Port Out	By-pass	Wgt	Price
DELTA-75-WOC 	19.5	560	Three-diaphragm pump with universal drive face, pulsation dampener, control unit, adjustable pressure regulator, manual dump valve, dual ball valve outlets, pressure gauge.	1-1/4"	0	0	44	\$1,497
DELTA-75				1-1/4"	1/2"	3/4"	46	1,772
DELTA-75/GR	19.5	560	DELTA-75 with a gear reduction for 11-13 hp gasoline engines	1-1/4"	2-1/2"	3/4"	58	2,307
			6062.E4 Diaphragm kit					159.85
			8700.75CK Diaphragm kit with bolt, washer, valves, and o-rings					404.68
Model	Max GPM	Max PSI	Description	HB Port In	HB Port Out	By-pass	Wgt	Price
DELTA-100-WOC 	26	560	Four-diaphragm pump with universal drive face, pulsation dampener, control unit, adjustable pressure regulator, manual dump valve, dual ball valve outlets, pressure gauge.	1-1/4"	2-1/2"	3/4"	49	\$1,856
DELTA-100/GR	26	560	DELTA-100 with a gear reduction for 16-18 hp gasoline engines	1-1/4"	2-1/2"	3/4"	58	2,843
			8700.80 Diaphragm kit					197.60
			8700.80CK Diaphragm kit with bolt, washer, valves, and o-rings					539.00
Model	Max GPM	Max PSI	Description	HB Port In	HB Port Out	By-pass	Wgt	Price
DELTA-140/TS2C 	36	725	Four-diaphragm pump, pulsation dampener, control unit, adjustable pressure regulator, manual dump valve, dual ball valve outlets, pressure gauge. Universal drive face on the back and 1-3/8" 6-spline male PTO shaft on the front.	1-1/2"	(1)3/4" Male NPT	1"	105	\$3,052
DELTA-140/GR	36	725	DELTA-140 with gear reduction for use on 24 hp gasoline engines with 1" shaft	1-1/2"	(1)3/4" Male NPT	1"	105	3,929
			6062.H5 Diaphragm kit					248.30
			8700.83CK Diaphragm kit with bolt, washer, valves, and o-rings					704.60
UDOR KAPPA Gear Kit			#6063.U1	For K-40 to K-43 Conversion			\$155.00	

UDOR IOTA SERIES DIAPHRAGM PUMPS

Model	Max GPM	Max PSI	Description	HB Port In	HB Port Out	Bypass	Wgt	Price
IOTA-20 	5	275	Two-diaphragm pump, pulsation dampener, control unit, adjustable pressure regulator, manual dump lever, pressure gauge. Also a replacement for any IOTA-17.	3/4"	3/8"	5/8"	14	\$696.00
IOTA-20/GR	5	275	IOTA-20 pump with gear reduction for 3-5 hp gasoline engines with 3/4" shafts	3/4"	3/8"	5/8"	17	918.00
			8700.01	Diaphragm kit				73.20
			8700.01CK	Diaphragm kit with bolt, washer, valves, and o-rings				218.40





UDOR ZETA SERIES DIAPHRAGM PUMPS

Model	Max GPM	Max PSI	Description	HB Port In	HB Port Out	Bypass	Wgt	Price
ZETA-85 	22	300	Three-diaphragm pump, control unit, adjustable pressure regulator, manual dump lever, dual ball valve outlets and pressure gauge.	1-1/2"	2-1/2"	3/4"	36	\$1,439
ZETA-85/GR-5	22	300	Fitted with gear box for 4-6.5 hp gasoline engines with 3/4" shafts.	1-1/2"	(2) 1/2"	3/4"	48	1,889
			6062.97	Diaphragm kit				149.88
			8700.60CK	Diaphragm kit with bolt, washer, valves, and o-rings				484.90

Model	Max GPM	Max PSI	Description	HB Port In	HB Port Out	Bypass	Wgt	Price
ZETA-120 	31	200	Three-diaphragm pump with pulsation dampener, aluminum head and body with glass filled nylon manifold. Does NOT include pressure regulator.	1-1/2"	3/4"	N/A	45	\$1,630
ZETA-120/GR-5	31	200		1-1/2"	3/4"	N/A	55	2,165
			6062.H2	Diaphragm kit				193.60
			8700.04CK	Diaphragm kit with bolt, washer, valves, and o-rings				510.00
6005.31/LPN 			Pump or remote mounted control unit includes an adjustable regulator with manual dump level					260.00
			6062.93	Repair Kit				36.12

UDOR PUMP MOUNTED CONTROL UNITS





(Specifically designed for use on UDOT diaphragm pumps)

Model	Max GPM	Max PSI	Description	Price
6010.93 	20	560	Pump or remote mounted control with right angle entry from main body to adjustable pressure regulator for smoother operation and longer life. Includes manual dump lever, two 1/2" ball valve discharge ports and pressure gauge. Standard on KAPPA-33, KAPPA-43 and KAPPA-53. Replacement for GS40GI, Hypro D-30, D-50. Repair kit 6062.A9	\$247.90 70.13
6010.95 	20	350	Same as 6010.93 except regulator is fitted with a lighter spring and gauge for lower pressure applications. Standard on KAPPA-25, ZETA-40, ZETA-85/GR-5 Repair kit 6062.A9	247.90 70.13
6010.24 	20	560	Pump or remote mounted control with adjustable pressure regulator with manual dump lever. Includes two 1/2" ball valve discharge ports and pressure gauge. Standard on Delta/Kappa 40, Kappa 55. Repair kit 6062.55 (expanded kit)	247.90 79.98
6047.06 	26	560	Pump or remote mounted control with right angle entry from main body to adjustable pressure regulator for smoother operation and longer life. Includes manual dump lever, two 1/2" ball valve discharge ports and pressure gauge. Standard on DELTA-75 & KAPPA-100. Repair kit 8701.02 (steel poppet and seat)	322.86 82.00
0604.27			RV elbow, nut, o-ring	24.90
0604.30			Control unit discharge nut, assembly	16.90

UDOR KAPPA / DELTA SERIES DIAPHRAGM PUMP KITS

Kappa 40	8700.02 8700.02CK	Diaphragm kit Diaphragm kit with bolt, washer, valves, and o-rings	\$98.80 292.00	Kappa 100	8700.24 8700.24CK	Diaphragm kit Diaphragm kit with bolt, washer, valves, and o-rings	\$150.20 541.00
Kappa 75	8700.10 8700.10CK	Diaphragm kit Diaphragm kit with bolt, washer, valves, and o-rings	\$137.00 410.00	Kappa 121	8700.22 8700.22CK	Diaphragm kit Diaphragm kit with bolt, washer, valves, and o-rings	\$208.00 636.00

UDOR FITTINGS, ADAPTERS, AND ACCESSORIES

Item Number	Description	Price
207P-12 	Brass coupler with 3/4" female metric thread by 3/4" male metric port of 6010.24, 6010.93, 6010.95 & 6047.06 pump mounted control units to provide a 3/4" female NPT discharge port. Can also be used as a 3/4" female NPT inlet port for KAPPA-15/18 & IOTA-17 pumps.	\$19.10
207P-12/90	Same as above with 90° nozzle elbow	29.68
207P-14 	Brass coupler with 1-1/4" female metric thread by 1-1/4" female NPT. Installs on 1-1/4" male metric inlet port of KAPPA 30/33/43/53/55/75 pumps to provide 1-1/4" female NPT inlet.	68.21
207P-16 	Brass coupler with 1-1/2" female metric thread by 1-1/2" female NPT. Installs on pump with 1-1/2" male thread.	80.00
15.5823 	UDOR Lube – specially formulated and molly enhanced for diaphragm pumps. UDOR warranties are only honored with the use of this lube. Quart bottles	14.95
15.5823/S	UDOR Lube – specially formulated for cold weather use in diaphragm pumps when temperatures are consistently below 30°. Quart bottles	33.68

Heavy Gauge Steel Base Plates

For pump and engines



9700.00	14" x 26"	\$142.50
9700.10	14" x 29"	150.60
9700.15	14" x 36"	172.60

12-VOLT PUMPS

12-volt and 115-volt diaphragm pumps are compact, dependable, lightweight, quiet, and versatile. These are positive displacement pumps, available with internal bypass or demand switch motors. 12-volt pumps have viton valves and continuous duty motors. 115-volt pumps have EPDM valves. All have santoprene diaphragms. 115-volt pumps have power cord. Warranty issues on 12-volt pumps are handled as a repair, not exchange.



Order No	GPM @ PSI	Style	Application	Price
8020-513-236	1.4 @ 60	Switch	115-volt motor	\$263.00
SLV10-AA40	1.0 @ 40	Switch	Spot sprayer	102.00
8000-543-236	1.4 @ 60	Switch	Spot sprayer	173.75
8007-543-836	1.8 @ 60	Switch	Fuse/switch	186.49
8006-543-250	1.4 @ 45	Bypass	Foam marker	169.14
2088-394-144	3.0 @ 45	Switch	115-volt motor	316.16
2088-343-135	3.0 @ 45	Switch	Sprayer	207.34
2087-593-135	3.0 @ 45	Switch	Fuse/switch	216.61
2088-514-144	4.0 @ 45	Switch	Sprayer	297.00
4211-035	6.25 @ 45	Switch	Sprayer	427.00
34-007			Heat sink	34.00

Swivel Fittings

Order No	Description	Price
234-2916	Swivel, 3/8" straight	\$2.31
234-2926	Swivel, 1/2" straight	2.31
234-2936	Swivel, 5/8" straight	2.96
234-2946	Swivel, 3/4" straight	2.31
234-3916	Swivel, 3/8" elbow	2.31
234-3926	Swivel, 1/2" elbow	2.31
234-3936	Swivel, 5/8" elbow	3.32
234-3946	Swivel, 3/4" elbow	2.31
244-3366	Swivel, 1/2" NPT elbow	4.50

12-Volt and 115-Volt Diaphragm Repair Kits

Series	Diaphragm Kit	Valve Kit	Check Valve Kit	Housing Kit	Housing and Switch	Switch Kit
2088	94-238-03 \$52.10	94-232-05 \$75.80	94-237-05 \$28.00	94-231-30 \$22.30	94-231-05 \$83.10	94-230-36 Viton \$39.60
4000	94-238-03 \$52.10	94-232-05 \$75.80	94-237-05 \$28.00	94-231-30 \$22.30	94-230-55 \$47.15	94-230-36 Viton \$39.60
4000	94-389-00 Manifold \$43.70					
8000	94-395-05 Viton \$79.70	94-390-05 Viton \$57.90	94-374-05 \$17.50	94-379-00 \$29.60		94-375-05 Viton \$48.70
SLV10	No parts available					

Viton valves available for use with petroleum-based products, lower quality surfactants, metholated seed oil, and dyes containing alcohol.

12-Volt Pump Wiring and Operational Instructions

- Wire pump directly to battery terminals using round eyelet connectors, **not alligator clips**
- Use 10 to 12-gauge wire from battery to pigtail of pump
- Install a 25-amp fuse or circuit breaker between battery and pump
- For proper pump operation, use a battery tender or charger to keep battery fully charged at all times
- Install a large enough nozzle on handgun to ensure the pump does not cycle on/off during operation
- Install a strainer assembly on suction side of pump, to prevent foreign particles from damaging valves
- Do not use well water that contains minute sand particles for filling sprayer (as it will damage valves)
- If pump heats up during normal operation, check all electrical connections and make sure battery is fully charged to supply 14 amps
- The use of surfactants with alcohol, MSO's, certain brands of colorants, or diesel fuel will lessen the life of the valve assembly



DURA-PUMP™ CHEMICAL PUMPS AND METERS

Dura-Pump™ Easy Caddy Systems and Pumps

- Flow to 18 gpm • 1" ports • Self-priming with internal bypass



DP-6018E-110	110-volt pump only, EPDM	\$724.00
DP-6018E-12	12-volt pump only, EPDM	698.00
DPB-6018E-12	12-volt pump with 2" coupler for bottom unload and 12' discharge hose	732.00
DPB-6018E-110	110-volt pump with 2" coupler for bottom unload and 12' discharge hose	773.00
DPE-6018E-12	Easy Caddy, 12-volt, mounts on tote with suction and discharge kit, EPDM	760.00
DPE-6018E-110	Easy Caddy, 110-volt, mounts on tote with suction discharge kit, EPDM w/o meter	834.00
DPEM-6318E-12	Easy Caddy with meter, mounts on tote with suction and discharge kit, EPDM	1,070.00

Dura™ Auto Batch Systems

- Offering an automated dispensing • Simply select volume desired and press start, auto shut off
- Flow to 18 gpm • Includes 5' suction, 12-volt discharge hose and 1" ports

DP-ABS-6318E-12	Easy caddy, auto batch, 12-volt, EPDM	\$1,585.00
DP-ABS-6318V-12	Easy caddy, auto batch, 12-volt, Viton	1,691.00
DP-ABS-6318V-110	Easy caddy, auto batch, 115-volt, Viton	1,679.00



Dura-Meter

- 100% moisture sealed
- Tough and impact resistant
- AAA batteries
- Flow rate 2-22 gpm • 1" ports



DP-3000E 1" Dura Meter, EPDM
\$327.00

DP-HFM3E 3" High Flow Flanged Meter
\$1,290.00

FLOJET DIAPHRAGM PUMPS



451F-1685-20	4.5 gpm, 12-volt, 14-amp max, pressure switch, 60 psi	\$209.00
	Reversed for Jackrabbit ATV	215.00
4420-753	4.5 gpm, sensor controlled, 12-amp max, pressure switch, 45 psi, Santo/Viton	314.00
4420-753R	Reversed for Jackrabbit ATV	321.00

Plug-in Quad Ports

20381-002	1/2" Straight HB	\$3.50
20381-006	3/4" Straight HB	3.50
20381-008	1/2" Elbow with 1/2" MPT	3.50
20381-009	1/2" Elbow HB	3.50

Repair Kits

02090-103	Pressure switch	\$52.25
20403-040	Diaphragm kit	22.95
20407-020	Check valve kit, viton	46.10
20407-030	Check valve kit, EPDM	35.85

Upper Housing Kit with Pressure Switch

20404-017	For 4300-504	\$94.26
20404-028	For 4420-753	92.20

HYPRO AQUA TIGER

9700B \$456.00



- Bronze centrifugal transfer pump close coupled to a 12-volt electric motor
- Maximum current draw is 5.5 amps
- 3/4" NPT inlet and 3/4" NPT outlet
- Max 19.0 gpm and 7 psi

SHURFLO 5000 SERIES 12-VOLT PUMP

- 5.3 gpm • Viton valves • 1/2" male port • Automatic demand version to 60 psi
- Bypass version to 90 psi • Requires up to 18 amp



5059-3611 bypass, 90 psi - \$278.00

5059-1311 with pressure switch, 60 psi - \$278.00

Model No	Switch Only	Upper Housing	Valve Assembly	Drive Assembly	Check Valve
5059-3611	N/A	94-910-14 \$56.15	94-910-05 \$65.10	94-910-04 \$101.85	N/A
5059-1311	94-910-02 \$29.21	94-910-15 \$37.65	94-910-05 \$65.10	94-910-04 \$101.85	94-910-03 \$21.65

PUMPS



DELAVAN POWER FLO 12-VOLT PUMP

5-chamber positive displacement pump, self-priming, capable of being run dry, demand or bypass mode, 12-volt permanent magnet, totally enclosed.



5850

7870

5850-201C	5.0 gpm demand pump with viton valves, santoprene diaphragm, 45 psi, 1/2" FNPT port	\$210.00
5850-201E	5.0 gpm demand pump with viton valves, santoprene diaphragm, 60 psi, 1/2" FNPT port	210.00
5850-111E	5.0 gpm bypass pump, viton valve, santoprene diaphragm, 70 psi, 1/2" FNPT port	252.00
7870-101E-SB	7.0 gpm demand pump, viton valves, santoprene diaphragm 60 psi, 1/2" FNPT port	399.00

7800-PSW-100	Pressure switch	7800	\$28.00
LHA-5850	Lower housing	5800	60.00
LHA-7870	Lower housing	7800	66.00
VHA-5800	Valve assembly	5800	47.30
VHA-7870	Valve assembly	7800	52.25

UHA-5800-PS	Upper housing pressure switch	5800	\$77.00
UHA-5800-B	Upper housing bypass	5800	55.00
UHA-7800-B	Upper housing bypass	7800	66.00
UHA-7800-PS	Upper housing pressure switch	7800	66.00

HYPRO CENTRIFUGAL SPRAYER PUMPS FOR FERTILIZER, AG CHEMICAL, ETC

Model	Description	PSI	Size	Price
1538	Pump only	70	1-1/2"x1-1/4"	\$ 695
1538	Pump with GX160 Honda engine	70	1-1/2"x1-1/4"	1,277
1538SP	Pump only, self-priming	65	2" x 2"	1,203
1538SP	Self-priming with GX160 Honda engine	65	2" x 2"	1,758
1551	Pump only	140	2" x 1-1/2"	1,287
1551	Pump with GX270 Honda engine	140	2" x 1-1/2"	2,341
1551	Pump with GX270 Honda electric start engine	140	2" x 1-1/2"	2,535
1551SP	Self-priming	140	2" x 2"	2,195
1551SP	Self-priming with GX270 Honda engine	140	2" x 2"	2,770
1551SP	Self-priming with GX20 Honda electric start engine	140	2" x 2"	3,349



We stock parts
for Hypro
centrifugal
pumps

3430-0332	Viton seal kit for 1538	\$67.35
3430-0464	Viton seal kit for 1551	252.00
0402-9200P	Impeller for 1538	148.95
0404-9200P	Impeller for 1551	353.10

ACE CENTRIFUGAL PUMP AND ENGINE UNITS

Model	Description	Price
GE-85-LE	Pump only, 24 gpm, 3/4" shaft, 65 psi	\$381.00
GE-85	Pump w/GX120 Honda engine	957.00
GE-85-SP-LE	Pump only, 24 gpm, 65 psi, 3/4" shaft	419.00
GE-85-SP	Pump with GX160 Honda engine	1,005.00
GE-660-LE	Pump only, 110 gpm, 113 psi, 1-1/2" x 1-1/4"	752.00
GE-660	Pump w/GX200 QA2 Honda engine, 110 gpm 113 psi	1,268.00
GE-660	Pump w/GX200 QE2 Honda electric start engine	1,657.00
GE-800-LE	Pump only, threaded shaft	1,544.00
GE-860-LE	Pump only, 140 gpm, 140 psi, 2" x 1-1/2"	1,476.00
GE-860	Pump w/GX270 QAE2 Honda electric start engine	2,522.00



ACE Seal Kits

Pump Model	Part No - Ceramic	Price	Part No - Silicon Carbide and Graphite	Price
GE-75	RK-GE-75	\$85.75	RK-GESC-75	\$212.00
GE-85	RK-GE-85	100.25	RK-GESC-85	255.00
GE-660	RK-GE-660	92.25	RK-GES-660	247.00
GE-800	RK-GE-800/1600	170.00	RK-GE-800/1600-SG	364.00
GE-860	RK-GE-860/1660	188.00	RK-GESG-860/1660	398.00
GE-85SP	RK-GE-85SP	112.00	RK-GESC-85SP	267.00

ACE Impellers

Pump Model	Part No	Price	Pump Model	Part No	Price
ACE75	42710	\$71.75	ACE660	30556 Thermoplastic	\$138.00
ACE85	42711	71.75	ACE800	30047	565.00
ACE650	30173	404.00	ACE860	30558	565.00

PUMPS

PACER

Transfer Pump Powered by Honda Engines

- Use for water, fertilizer, ag chemical
- Suction lift to 25' • 230 gpm open flow
- 2" inlet and outlet NPT



SE2UL E5HCP	Honda GX160, commercial	\$698.00*
SE2UL	Pump only	284.00*
SE2SL E5HCPLES	Honda GX160, electric start	1,236.00*
58-0074	Seal kit	48.80*
58-070230	Valve	69.20*
58-070572	Check valve	32.00*
58-070630	Impeller	34.60*
58-071972	O-ring	18.00*
58-100230B	Pump body	112.00*
P-58-702EP-U	Pump repair kit	128.00*

Self-Priming 2 hp Centrifugal Transfer Pump



- Use for water, fertilizer, liquid feed, etc
- 2"x2" EPDM fitted, with single phase motor
- Impeller / seal / rebuilt kit

SE2ELC2.OC 1 Phase 115/230 **\$999.00***

- 3" inlet and outlet, 400 gpm max, Honda GX390 electric start engine



TE3TEPE390CCH **\$2,265.00***

Pacer Polypropylene Hand Pump, Double Acting for Water, Ag Chemical, Fertilizer, Etc

- HPN-1-A Pump \$188.00
Includes 8' discharge hose and suction tube; works on 30 & 55-gallon barrels
- P-58-01678P Viton kit \$56.30
- Vacuum breaker with vent plug \$17.60



REPLACEMENT PUMP AND ENGINE UNIT

\$1,590.00

- Honda GX160 engine • Oil Drainzit
- 8-roller pump (22 gpm, 250 psi)
- Chain coupler • Chain guard
- Pressure relief valve
- Suction strainer
- Winterization tee • Pressure gauge
- Mounted on heavy duty steel baseplate



Protect Your Transfer Pump

Pump and engine cover fits most size and brands of 2" and 3" pump and engine units.



AVPC01 **\$129.00 each**

KOSHIN

High Pressure Centrifugal Pump

- 1-1/2" inlet and outlet
- Honda GX50 engine
- 30 gpm and pressures to 64 psi
- Maximum suction lift 26'
- Excellent sprayer or transfer pump
- Not rated for fertilizer



SEH-40H 1-1/2" NPT **\$695.00**

- Same specs as above engine except 1" inlet and outlet
- 10 gpm and pressures to 64 psi
- Very nice pump and engine for small sprayer
- Not rated for fertilizer

SEH-40H 1" **\$735.00**

011068503 Seal for Koshin SEH-401X \$71.00*

0115014 O-ring for Koshin SEH-401X 6.90*

Super Light Weight Transfer Pump



- 1" inlet and outlet, 30 gpm
- Honda GXH25 engine
- Weight 12 lbs
- Maximum suction lift 26'
- Maximum pressure 47 psi
- Very portable unit to fill sprayer in field

SEH-25L **\$556.00**

Trash Pump

- 3" inlet and outlet
- Honda GX270 engine
- Maximum 338 gpm, 38.5 PSI
- Not for fertilizer

KTH-80S **\$2,017.00**



Trash Pump

- 2" inlet and outlet
- Honda GX160 engine
- Maximum 185 gpm, 42.4 psi
- Not for fertilizer

KTH-50X **\$1,567.00**

JOHN BLUE TRANSFER PUMP

SP-3240-G5H - **\$1,305.00**

SP-3240 pump only - **\$639.00**

Electric start engine - **Add \$360.00**



- 2" self-priming poly centrifugal pump
- GX160 Honda engine • 2" inlet and outlet FPT
- Max flow 200 gpm • Max pressure 42 psi
- Double wet seal assembly, pump can be run dry without causing seal failure; seal is antifreeze cooled
- Pump can be removed, or engine can be replaced without having to disassemble the pump





SPRAYING SYSTEMS ACCESSORIES

<p>Standard Nozzle Caps </p> <table border="1" style="width: 100%; border-collapse: collapse;"> <tr><td>CP8027NYB</td><td>Poly</td><td>\$1.45</td></tr> <tr><td>CP1325</td><td>Brass</td><td>2.15</td></tr> <tr><td>CP1325-AL</td><td>Aluminum</td><td>2.05</td></tr> <tr><td>CP4743-NY</td><td>Gasket</td><td>2.44</td></tr> </table>	CP8027NYB	Poly	\$1.45	CP1325	Brass	2.15	CP1325-AL	Aluminum	2.05	CP4743-NY	Gasket	2.44	<p>Male Nozzle Body, Brass </p> <table border="1" style="width: 100%; border-collapse: collapse;"> <tr><td>CP1322</td><td>1/4TT</td><td>\$3.51</td></tr> <tr><td>CP1324</td><td>3/8TT</td><td>3.51</td></tr> <tr><td>CP1336</td><td>1/8TT</td><td>3.51</td></tr> <tr><td>CP1340</td><td>1/2TT</td><td>12.69</td></tr> </table>	CP1322	1/4TT	\$3.51	CP1324	3/8TT	3.51	CP1336	1/8TT	3.51	CP1340	1/2TT	12.69	<p>Connector Bodies, Brass </p> <table border="1" style="width: 100%; border-collapse: collapse;"> <tr><td>90.900.52</td><td>1/2" Single</td><td>\$16.90</td></tr> <tr><td>90.900.53</td><td>1/2" Single</td><td>16.90</td></tr> </table>	90.900.52	1/2" Single	\$16.90	90.900.53	1/2" Single	16.90
CP8027NYB	Poly	\$1.45																														
CP1325	Brass	2.15																														
CP1325-AL	Aluminum	2.05																														
CP4743-NY	Gasket	2.44																														
CP1322	1/4TT	\$3.51																														
CP1324	3/8TT	3.51																														
CP1336	1/8TT	3.51																														
CP1340	1/2TT	12.69																														
90.900.52	1/2" Single	\$16.90																														
90.900.53	1/2" Single	16.90																														
<p>Nozzle Blanks </p> <table border="1" style="width: 100%; border-collapse: collapse;"> <tr><td>CP3942</td><td>Brass</td><td>\$.74</td></tr> <tr><td>CP3942-SS</td><td>Stainless Steel</td><td>.74</td></tr> </table>	CP3942	Brass	\$.74	CP3942-SS	Stainless Steel	.74	<p>Female Nozzle Body, Brass </p> <table border="1" style="width: 100%; border-collapse: collapse;"> <tr><td>CP1323</td><td>3/8T</td><td>\$6.01</td></tr> <tr><td>CP1321</td><td>1/4T</td><td>6.01</td></tr> <tr><td>CP1335</td><td>1/8T</td><td>3.51</td></tr> <tr><td>CP1339</td><td>1/2T</td><td>12.69</td></tr> </table>	CP1323	3/8T	\$6.01	CP1321	1/4T	6.01	CP1335	1/8T	3.51	CP1339	1/2T	12.69	<p>Nozzle Checks </p> <table border="1" style="width: 100%; border-collapse: collapse;"> <tr><td>4193A</td><td>50M Brass 5 psi .8 gpm</td><td>7.33</td></tr> <tr><td>4193A</td><td>100M Brass 5 psi .8 gpm</td><td>7.33</td></tr> </table>	4193A	50M Brass 5 psi .8 gpm	7.33	4193A	100M Brass 5 psi .8 gpm	7.33						
CP3942	Brass	\$.74																														
CP3942-SS	Stainless Steel	.74																														
CP1323	3/8T	\$6.01																														
CP1321	1/4T	6.01																														
CP1335	1/8T	3.51																														
CP1339	1/2T	12.69																														
4193A	50M Brass 5 psi .8 gpm	7.33																														
4193A	100M Brass 5 psi .8 gpm	7.33																														
<p>Nozzle Strainers </p> <table border="1" style="width: 100%; border-collapse: collapse;"> <tr><td>8079-PP-50</td><td>50M Polyprop</td><td>\$1.88</td></tr> <tr><td>8079-PP-100</td><td>100M Polyprop</td><td>1.88</td></tr> <tr><td>5053-50</td><td>50M Brass</td><td>4.42</td></tr> <tr><td>5053-100</td><td>100M Brass</td><td>4.42</td></tr> </table>	8079-PP-50	50M Polyprop	\$1.88	8079-PP-100	100M Polyprop	1.88	5053-50	50M Brass	4.42	5053-100	100M Brass	4.42	<p>Nozzle Body Adapters </p> <table border="1" style="width: 100%; border-collapse: collapse;"> <tr><td>4676-1/8"</td><td>1/8" Brass</td><td>\$4.37</td></tr> <tr><td>4676-1/4"</td><td>1/4" Brass</td><td>4.37</td></tr> <tr><td>4676-3/4"</td><td>3/4" Brass</td><td>18.39</td></tr> </table>	4676-1/8"	1/8" Brass	\$4.37	4676-1/4"	1/4" Brass	4.37	4676-3/4"	3/4" Brass	18.39	<p>Drop Nozzle Pipe </p> <table border="1" style="width: 100%; border-collapse: collapse;"> <tr><td>21353-6-24-NYB</td><td>24" nylon</td><td>\$13.54</td></tr> </table>	21353-6-24-NYB	24" nylon	\$13.54						
8079-PP-50	50M Polyprop	\$1.88																														
8079-PP-100	100M Polyprop	1.88																														
5053-50	50M Brass	4.42																														
5053-100	100M Brass	4.42																														
4676-1/8"	1/8" Brass	\$4.37																														
4676-1/4"	1/4" Brass	4.37																														
4676-3/4"	3/4" Brass	18.39																														
21353-6-24-NYB	24" nylon	\$13.54																														
		<p>Lite Weight Clamps</p> <table border="1" style="width: 100%; border-collapse: collapse;"> <tr><td>BC-34R</td><td>3/4" Round</td><td>\$5.12</td></tr> <tr><td>BC1000R</td><td>1" Round</td><td>7.09</td></tr> <tr><td>BC100</td><td>1" Square</td><td>5.48</td></tr> <tr><td>BC114</td><td>1-1/4" Square</td><td>10.37</td></tr> </table>	BC-34R	3/4" Round	\$5.12	BC1000R	1" Round	7.09	BC100	1" Square	5.48	BC114	1-1/4" Square	10.37																		
BC-34R	3/4" Round	\$5.12																														
BC1000R	1" Round	7.09																														
BC100	1" Square	5.48																														
BC114	1-1/4" Square	10.37																														

Quick TeeJet Nozzle Systems for Dry Booms

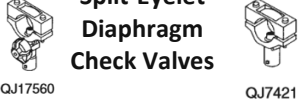
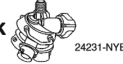
<p>Multiple Nozzle Hose Shank Diaphragm Check Valves</p>	<table border="1" style="width: 100%; border-collapse: collapse;"> <tr><td>QJ363-*-1-NYB</td><td>-500, -750, -1000 Nozzle body with single hose shank</td><td>\$25.20 each</td></tr> <tr><td>QJ363-*-2-NYB</td><td>-500, -750, -1000 Nozzle body with double hose shank</td><td>25.20 each</td></tr> <tr><td>QJ365-*-1-NYB</td><td>-500, -750, -1000 Nozzle body with single hose shank</td><td>25.20 each</td></tr> <tr><td>QJ365-*-2-NYB</td><td>-500, -750, -1000 Nozzle body with double hose shank</td><td>25.20 each</td></tr> <tr><td>24230-B-1-*</td><td>-406, -540, -785 Triple nozzle body with single hose shank</td><td>27.80 each</td></tr> <tr><td>24230-A-2-*</td><td>-406, -540, -785 Triple nozzle body with double hose shank</td><td>27.80 each</td></tr> </table>	QJ363-*-1-NYB	-500, -750, -1000 Nozzle body with single hose shank	\$25.20 each	QJ363-*-2-NYB	-500, -750, -1000 Nozzle body with double hose shank	25.20 each	QJ365-*-1-NYB	-500, -750, -1000 Nozzle body with single hose shank	25.20 each	QJ365-*-2-NYB	-500, -750, -1000 Nozzle body with double hose shank	25.20 each	24230-B-1-*	-406, -540, -785 Triple nozzle body with single hose shank	27.80 each	24230-A-2-*	-406, -540, -785 Triple nozzle body with double hose shank	27.80 each									
QJ363-*-1-NYB	-500, -750, -1000 Nozzle body with single hose shank	\$25.20 each																										
QJ363-*-2-NYB	-500, -750, -1000 Nozzle body with double hose shank	25.20 each																										
QJ365-*-1-NYB	-500, -750, -1000 Nozzle body with single hose shank	25.20 each																										
QJ365-*-2-NYB	-500, -750, -1000 Nozzle body with double hose shank	25.20 each																										
24230-B-1-*	-406, -540, -785 Triple nozzle body with single hose shank	27.80 each																										
24230-A-2-*	-406, -540, -785 Triple nozzle body with double hose shank	27.80 each																										
<p>Hose Shank Diaphragm Check Valves</p>	<table border="1" style="width: 100%; border-collapse: collapse;"> <tr><td>19349-211-*-NYB</td><td>-406, -540, -785 Single hose shank quick TeeJet nozzle body with diaphragm check valve</td><td>\$12.90 each</td></tr> <tr><td>19350-212-*-NYB</td><td>-406, -540, -785 Double hose shank quick TeeJet nozzle body with diaphragm check valve</td><td>12.90 each</td></tr> <tr><td>19351-213-*-NYB</td><td>-406, -540, -785 Triple hose shank quick TeeJet nozzle body with diaphragm check valve</td><td>12.90 each</td></tr> <tr><td>22251-311-*-NYB</td><td>-375, -550, -750 Single hose shank quick TeeJet nozzle body with diaphragm check valve</td><td>10.80 each</td></tr> <tr><td>22252-312-*-NYB</td><td>-375, -550, -750 Double hose shank quick TeeJet nozzle body with diaphragm check valve</td><td>10.80 each</td></tr> </table>	19349-211-*-NYB	-406, -540, -785 Single hose shank quick TeeJet nozzle body with diaphragm check valve	\$12.90 each	19350-212-*-NYB	-406, -540, -785 Double hose shank quick TeeJet nozzle body with diaphragm check valve	12.90 each	19351-213-*-NYB	-406, -540, -785 Triple hose shank quick TeeJet nozzle body with diaphragm check valve	12.90 each	22251-311-*-NYB	-375, -550, -750 Single hose shank quick TeeJet nozzle body with diaphragm check valve	10.80 each	22252-312-*-NYB	-375, -550, -750 Double hose shank quick TeeJet nozzle body with diaphragm check valve	10.80 each												
19349-211-*-NYB	-406, -540, -785 Single hose shank quick TeeJet nozzle body with diaphragm check valve	\$12.90 each																										
19350-212-*-NYB	-406, -540, -785 Double hose shank quick TeeJet nozzle body with diaphragm check valve	12.90 each																										
19351-213-*-NYB	-406, -540, -785 Triple hose shank quick TeeJet nozzle body with diaphragm check valve	12.90 each																										
22251-311-*-NYB	-375, -550, -750 Single hose shank quick TeeJet nozzle body with diaphragm check valve	10.80 each																										
22252-312-*-NYB	-375, -550, -750 Double hose shank quick TeeJet nozzle body with diaphragm check valve	10.80 each																										
<p>Hose Shank Nozzle Bodies</p>	<table border="1" style="width: 100%; border-collapse: collapse;"> <tr><td>18635-111-406-NYB</td><td>3/8" Single hose shank quick TeeJet nozzle body</td><td>\$5.20 each</td></tr> <tr><td>18638-111-540-NYB</td><td>1/2" Single hose shank quick TeeJet nozzle body</td><td>5.20 each</td></tr> <tr><td>18719-111-785-NYB</td><td>3/4" Single hose shank quick TeeJet nozzle body</td><td>5.20 each</td></tr> <tr><td>18636-112-406-NYB</td><td>3/8" Double hose shank quick TeeJet nozzle body</td><td>5.20 each</td></tr> <tr><td>18639-112-540-NYB</td><td>1/2" Double hose shank quick TeeJet nozzle body</td><td>5.20 each</td></tr> <tr><td>18720-112-785-NYB</td><td>3/4" Double hose shank quick TeeJet nozzle body</td><td>5.20 each</td></tr> <tr><td>18637-113-406-NYB</td><td>3/8" Triple hose shank quick TeeJet nozzle body</td><td>5.20 each</td></tr> <tr><td>18640-113-540-NYB</td><td>1/2" Triple hose shank quick TeeJet nozzle body</td><td>5.20 each</td></tr> <tr><td>18721-113-785-NYB</td><td>3/4" Triple hose shank quick TeeJet nozzle body</td><td>5.20 each</td></tr> </table>	18635-111-406-NYB	3/8" Single hose shank quick TeeJet nozzle body	\$5.20 each	18638-111-540-NYB	1/2" Single hose shank quick TeeJet nozzle body	5.20 each	18719-111-785-NYB	3/4" Single hose shank quick TeeJet nozzle body	5.20 each	18636-112-406-NYB	3/8" Double hose shank quick TeeJet nozzle body	5.20 each	18639-112-540-NYB	1/2" Double hose shank quick TeeJet nozzle body	5.20 each	18720-112-785-NYB	3/4" Double hose shank quick TeeJet nozzle body	5.20 each	18637-113-406-NYB	3/8" Triple hose shank quick TeeJet nozzle body	5.20 each	18640-113-540-NYB	1/2" Triple hose shank quick TeeJet nozzle body	5.20 each	18721-113-785-NYB	3/4" Triple hose shank quick TeeJet nozzle body	5.20 each
18635-111-406-NYB	3/8" Single hose shank quick TeeJet nozzle body	\$5.20 each																										
18638-111-540-NYB	1/2" Single hose shank quick TeeJet nozzle body	5.20 each																										
18719-111-785-NYB	3/4" Single hose shank quick TeeJet nozzle body	5.20 each																										
18636-112-406-NYB	3/8" Double hose shank quick TeeJet nozzle body	5.20 each																										
18639-112-540-NYB	1/2" Double hose shank quick TeeJet nozzle body	5.20 each																										
18720-112-785-NYB	3/4" Double hose shank quick TeeJet nozzle body	5.20 each																										
18637-113-406-NYB	3/8" Triple hose shank quick TeeJet nozzle body	5.20 each																										
18640-113-540-NYB	1/2" Triple hose shank quick TeeJet nozzle body	5.20 each																										
18721-113-785-NYB	3/4" Triple hose shank quick TeeJet nozzle body	5.20 each																										
<p>Vari-Spacing Clamps</p>	<table border="1" style="width: 100%; border-collapse: collapse;"> <tr><td>QJ111-1/2, -3/4 or -1</td><td>Vari-spacing quick TeeJet clamp sub-assembly</td><td>\$3.50 each</td></tr> <tr><td>QJ111-1 1/4</td><td>Vari-spacing quick TeeJet clamp sub-assembly</td><td>3.50 each</td></tr> <tr><td>QJ111SQ-3/4, or -1</td><td>Vari-spacing quick TeeJet clamp sub-assembly</td><td>3.50 each</td></tr> <tr><td>QJ111SQ-1 1/4</td><td>Vari-spacing quick TeeJet clamp sub-assembly</td><td>3.50 each</td></tr> <tr><td>QJ111SQ-1 1/2</td><td>Vari-spacing quick TeeJet clamp sub-assembly</td><td>3.50 each</td></tr> <tr><td>QJ111SQ-304SS</td><td>Same sizes as QJ111SQ above but stainless steel</td><td>8.20 each</td></tr> </table>	QJ111-1/2, -3/4 or -1	Vari-spacing quick TeeJet clamp sub-assembly	\$3.50 each	QJ111-1 1/4	Vari-spacing quick TeeJet clamp sub-assembly	3.50 each	QJ111SQ-3/4, or -1	Vari-spacing quick TeeJet clamp sub-assembly	3.50 each	QJ111SQ-1 1/4	Vari-spacing quick TeeJet clamp sub-assembly	3.50 each	QJ111SQ-1 1/2	Vari-spacing quick TeeJet clamp sub-assembly	3.50 each	QJ111SQ-304SS	Same sizes as QJ111SQ above but stainless steel	8.20 each									
QJ111-1/2, -3/4 or -1	Vari-spacing quick TeeJet clamp sub-assembly	\$3.50 each																										
QJ111-1 1/4	Vari-spacing quick TeeJet clamp sub-assembly	3.50 each																										
QJ111SQ-3/4, or -1	Vari-spacing quick TeeJet clamp sub-assembly	3.50 each																										
QJ111SQ-1 1/4	Vari-spacing quick TeeJet clamp sub-assembly	3.50 each																										
QJ111SQ-1 1/2	Vari-spacing quick TeeJet clamp sub-assembly	3.50 each																										
QJ111SQ-304SS	Same sizes as QJ111SQ above but stainless steel	8.20 each																										
<p>Vari-Spacing TeeJet Clamp Assemblies</p>	<table border="1" style="width: 100%; border-collapse: collapse;"> <tr><td>AA111-1/2, -3/4, -1</td><td>Clamp sub-assembly</td><td>\$5.75 each</td></tr> <tr><td>AA111-1-1/4</td><td>Clamp sub-assembly</td><td>9.48 each</td></tr> <tr><td>AA111SQ-1</td><td>Clamp sub-assembly</td><td>6.52 each</td></tr> <tr><td>AA111SQ-1-1/4</td><td>Clamp sub assembly</td><td>9.80 each</td></tr> <tr><td>AA111SQ-1-1/2</td><td>Clamp sub assembly</td><td>11.70 each</td></tr> </table>	AA111-1/2, -3/4, -1	Clamp sub-assembly	\$5.75 each	AA111-1-1/4	Clamp sub-assembly	9.48 each	AA111SQ-1	Clamp sub-assembly	6.52 each	AA111SQ-1-1/4	Clamp sub assembly	9.80 each	AA111SQ-1-1/2	Clamp sub assembly	11.70 each												
AA111-1/2, -3/4, -1	Clamp sub-assembly	\$5.75 each																										
AA111-1-1/4	Clamp sub-assembly	9.48 each																										
AA111SQ-1	Clamp sub-assembly	6.52 each																										
AA111SQ-1-1/4	Clamp sub assembly	9.80 each																										
AA111SQ-1-1/2	Clamp sub assembly	11.70 each																										

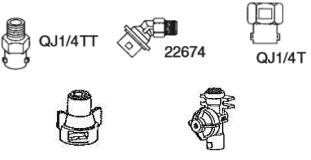
Quick TeeJet Nozzle Systems for Wet Booms

Multiple Nozzle Split-Eyelet Diaphragm Check Valves 	QJ363-*-NYB	-20MM, -25MM, -1/2, -3/4, -1" Split-eyelet diaphragm check valve	\$24.20 each
	QJ365-*-NYB	-20MM, -25MM, -1/2, -3/4, -1" Split eyelet diaphragm check valve	24.20 each
	24216-*-NYB	TeeJet triple nozzle body	14.50 each
Split-Eyelet Diaphragm Check Valves 	QJ17560-*-NYB	-1/2", -3/4", -1" Split-eyelet diaphragm check valve Quick TeeJet	\$3.90 each
	QJ7421-*-NYB	-1/2", -3/4", -1" Split-eyelet Quick TeeJet nozzle body	5.20 each
Multiple Nozzle Diaphragm Check Valve 	24231-NYB	TeeJet triple nozzle body with 1/4" inlet	\$28.45 each
Diaphragm Check Valves 	QJ8360-NYB	Diaphragm check valve Quick TeeJet nozzle body, 1/4" M	\$7.10 each
	QJ8355-*-NYB	-1/8", -1/4" Diaphragm check valve quick TeeJet nozzle body	13.05 each
Nozzle Bodies 	QJ1/4TT-NYB	Quick TeeJet nozzle body	\$3.55 each
	QJ1/4T-NYB	Quick TeeJet nozzle body	3.55 each
	22674-1/4-NYB	Quick TeeJet nozzle body	3.55 each
	QJ98590-3/8-NYB	3/8" Push-to-Connect body	15.80 each
	QJ98588-1/4-NYB	1/4" Push-to-Connect straight cap	7.40 each
Swivels 	QJ8600-1/4-NYB	Single swivel Quick TeeJet nozzle body	\$9.45 each
	QJ8600-2-1/4-NYB	Double swivel Quick TeeJet nozzle body	11.35 each
Swivel Nozzle Bodies 	N7620T	Single, brass	\$32.30 each
	N8600A	Single, nylon	12.26 each
	N7450	Double, brass	40.20 each
	N86002	Double, nylon	14.50 each



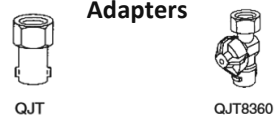



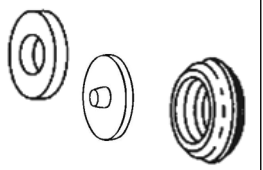



Quick TeeJet Adapters

Adapters 	QJT-NYB	Quick TeeJet adapter, fits TeeJet bodies using 1325 cap	\$6.65 each
	QJT8360-NYB	Diaphragm check valve Quick TeeJet body, fits TeeJet bodies using 1325 cap	7.35 each

Quick TeeJet Gaskets and Seals

	CP19438-EPR	Quick TeeJet seat gasket, standard EPDM material (for use with all spray tips except disc-core type)	\$0.67 each
	CP18999-EPR	Quick TeeJet seal, EPDM, for disc-core type spray tips	1.40 each
	CP21953-EPR	Diaphragm, EPDM rubber	0.62 each

TeeJet Spray Tips and Nozzles - Broadcast

	Type (Broadcast)	Size	Material	How To Order	Price	Quantity
	XR TeeJet Extended Range Tips (Tapered Flat Fan Spray) VisiFlo Color-Coded	All Sizes	Stainless Steel/Acetal Stainless Steel	XR8001 – XR8008VS Or XR11001VS – XR11010VS XR8010- XR8020VS	\$8.65 7.25 6.20 10.30	1 – 25 26 – 50 51 + Each
	TeeJet Spray Tips (Tapered Flat Fan Spray)	-0050 or smaller Larger than -0050	Brass Brass Stainless Steel	TP800050 TP800067	\$5.30 5.30 13.50	Each Each Each
	AIXR TeeJet Air Induction XR Flat Spray Tips	015-06 08-10	UHMWPE Polymer UHMWPE Polymer	AIXR110015-06VP ZIXR11008VP	\$9.10 7.75 7.50 10.60	1-25 26-50 51+ Each
	Turbo TeeJet Spray Tips (tapered Flat Fan Spray) VisiFlo Color-Coded	01-08	Acetal	TTI11001-8VP	\$8.18 6.85 5.85	1 – 25 26 – 50 51 +
	Turbo TeeJet Induction Air Induction Spray Tips (Tapered Flat Fan Spray) VisiFlo Color-Coded	0106 08-10	Acetal Acetal	TTI11004-VP TTI11008-VP	\$13.98 16.34	Each Each
	Turbo TwinJet (Twin Tapered Flat Fan Spray) VisiFlo Color-Coded	All Sizes	Acetal	TTJ60-11004VP	\$9.80	Each
	TeeJet OC Spray Tips (Off Center Flat Fan Spray)	-01 to -08, -12, -16	Brass Stainless Steel	OC-02 OC-SS02	\$13.90 20.46	Each Each
	Turbo FloodJet Spray Tips (Wide Angle Flat Fan Spray) VisiFlo Color-Coded	All Sizes	Stainless Steel/Acetal Acetal	TF-VS4	\$16.25 4.65	Each Each
	FloodJet Spray Tips (Wide Angle Flat Fan Spray)	All Sizes	Brass Stainless Steel	TK-3 TK-SS3	\$8.54 15.52	Each Each
	StreamJet SJ3Fertilizer Spray Tips (3 Solid Stream Orifices) VisiFlo Color-Coded	All Sizes	Acetal	SJ3-04-VP	\$11.20	Each
	PTC-VR Variable Rate Fertilizer Nozzles	Available for 1/4", 5/16", 3/8" OD tubing		PTC-VT-X1.0-1/4	\$34.70 30.85	1 - 15 15+

VeeJet® Flat Spray Nozzles

- Brass
- Flat spray pattern
- For magnesium chloride application, de-icing, dust control, liquid feed, many industrial machines



H3/4U	80200 thru 80400	\$61.70
H1/2U	8010 thru 80200	35.20
H3/8	Thru 80150	27.25
H1/4U	Thru 8070	26.20

Call for other nozzle sizes and specifications

Fertilizer Application Rate for Corn Planters

ORIFICE	PSI	GPM	GALLONS PER ACRE FOR 30" ROWS				
			4 mph	4.5 mph	5 mph	5.5 mph	6 mph
4916-28	20	0.069	2.80	2.49	2.24	2.04	1.87
	30	0.085	3.45	3.07	2.76	2.51	2.30
4916-37	20	0.122	4.95	4.40	3.96	3.60	3.30
	30	0.149	6.05	5.38	4.84	4.40	4.03
4916.43	20	0.163	6.62	5.88	5.29	4.81	4.41
	30	0.200	8.12	7.22	6.49	5.90	5.41
4916.48	20	0.202	8.20	7.29	6.56	5.96	5.47
	30	0.248	10.07	8.95	8.05	7.32	6.71
4916.52	20	0.237	9.62	8.55	7.70	7.00	6.41
	30	0.290	11.77	10.46	9.42	8.56	7.85
4916.57	20	0.283	11.49	10.21	9.19	8.35	7.66
	30	0.346	14.04	12.48	11.24	10.21	9.36

Other sizes available



CP4916_*
Orifice
Plate
\$3.92

CP18999
Orifice
Gasket
\$1.40





UNIVERSAL APPLICATION RATE CHART FOR 20" TIP SPACING

TIP CAPACITY	LIQUID PRESSURE IN PSI	CAPACITY ONE TIP IN GPM	CAPACITY ONE TIP IN OZ/MIN	GALLONS PER ACRE - 20" SPRAY TIP SPACING											
				4 MPH	5 MPH	6 MPH	7 MPH	8 MPH	10 MPH	12 MPH	14 MPH	16 MPH	18 MPH	20 MPH	22 MPH
01	15	0.061	7.8	4.5	3.6	3.0	2.6	2.3	1.8	1.5	1.3	1.1	1.0	0.91	0.82
	20	0.071	9.1	5.3	4.2	3.5	3.0	2.6	2.1	1.8	1.5	1.3	1.2	1.1	0.96
	30	0.087	11	6.5	5.2	4.3	3.7	3.2	2.6	2.2	1.8	1.6	1.4	1.3	1.2
	40	0.10	13	7.4	5.9	5.0	4.2	3.7	3.0	2.5	2.1	1.9	1.7	1.5	1.4
	50	0.11	14	8.2	6.5	5.4	4.7	4.1	3.3	2.7	2.3	2.0	1.8	1.6	1.5
	60	0.12	15	8.9	7.1	5.9	5.1	4.5	3.6	3.0	2.5	2.2	2.0	1.8	1.6
	75	0.14	18	10.4	8.3	6.9	5.9	5.2	4.2	3.5	3.0	2.6	2.3	2.1	1.9
	90	0.15	19	11.1	8.9	7.4	6.4	5.6	4.5	3.7	3.2	2.8	2.5	2.2	2.0
	15	0.092	12	6.8	5.5	4.6	3.9	3.4	2.7	2.3	2.0	1.7	1.5	1.4	1.2
20	0.11	14	8.2	6.5	5.4	4.7	4.1	3.3	2.7	2.3	2.0	1.8	1.6	1.5	
30	0.13	17	9.7	7.7	6.4	5.5	4.8	3.9	3.2	2.8	2.4	2.1	1.9	1.8	
40	0.15	19	11.1	8.9	7.4	6.4	5.6	4.5	3.7	3.2	2.8	2.5	2.2	2.0	
50	0.17	22	12.6	10.1	8.4	7.2	6.3	5.0	4.2	3.6	3.2	2.8	2.5	2.3	
60	0.18	23	13.4	10.7	8.9	7.6	6.7	5.3	4.5	3.8	3.3	3.0	2.7	2.4	
75	0.21	27	15.6	12.5	10.4	8.9	7.8	6.2	5.2	4.5	3.9	3.5	3.1	2.8	
90	0.23	29	17.1	13.7	11.4	9.8	8.5	6.8	5.7	4.9	4.3	3.8	3.4	3.1	
15	0.12	15	8.9	7.1	5.9	5.1	4.5	3.6	3.0	2.5	2.2	2.0	1.8	1.6	
20	0.14	18	10.4	8.3	6.9	5.9	5.2	4.2	3.5	3.0	2.6	2.3	2.1	1.9	
30	0.17	22	12.6	10.1	8.4	7.2	6.3	5.0	4.2	3.6	3.2	2.8	2.5	2.3	
40	0.20	26	14.9	11.9	9.9	8.5	7.4	5.9	5.0	4.2	3.7	3.3	3.0	2.7	
50	0.22	28	16.3	13.1	10.9	9.3	8.2	6.5	5.4	4.7	4.1	3.6	3.3	3.0	
60	0.24	31	17.8	14.3	11.9	10.2	8.9	7.1	5.9	5.1	4.5	4.0	3.6	3.2	
75	0.27	35	20	16.0	13.4	11.5	10.0	8.0	6.7	5.7	5.0	4.5	4.0	3.6	
90	0.30	38	22	17.8	14.9	12.7	11.1	8.9	7.4	6.4	5.6	5.0	4.5	4.1	
15	0.15	19	11.1	8.9	7.4	6.4	5.6	4.5	3.7	3.2	2.8	2.5	2.2	2.0	
20	0.17	22	12.6	10.1	8.4	7.2	6.3	5.0	4.2	3.6	3.2	2.8	2.5	2.3	
30	0.22	28	16.3	13.1	10.9	9.3	8.2	6.5	5.4	4.7	4.1	3.6	3.3	3.0	
40	0.25	32	18.6	14.9	12.4	10.6	9.3	7.4	6.2	5.3	4.6	4.1	3.7	3.4	
50	0.28	36	21	16.6	13.9	11.9	10.4	8.3	6.9	5.9	5.2	4.6	4.2	3.8	
60	0.31	40	23	18.4	15.3	13.2	11.5	9.2	7.7	6.6	5.8	5.1	4.6	4.2	
75	0.34	44	25	20	16.8	14.4	12.6	10.1	8.4	7.2	6.3	5.6	5.0	4.6	
90	0.38	49	28	23	18.8	16.1	14.1	11.3	9.4	8.1	7.1	6.3	5.6	5.1	
15	0.18	23	13.4	10.7	8.9	7.6	6.7	5.3	4.5	3.8	3.3	3.0	2.7	2.4	
20	0.21	27	15.6	12.5	10.4	8.9	7.8	6.2	5.2	4.5	3.9	3.5	3.1	2.8	
30	0.26	33	19.3	15.4	12.9	11.0	9.7	7.7	6.4	5.5	4.8	4.3	3.9	3.5	
40	0.30	38	22	17.8	14.9	12.7	11.1	8.9	7.4	6.4	5.6	5.0	4.5	4.1	
50	0.34	44	25	20	16.8	14.4	12.6	10.1	8.4	7.2	6.3	5.6	5.0	4.6	
60	0.37	47	27	22	18.3	15.7	13.7	11.0	9.2	7.8	6.9	6.1	5.5	5.0	
75	0.41	52	30	24	20	17.4	15.2	12.2	10.1	8.7	7.6	6.8	6.1	5.5	
90	0.45	58	33	27	22	19.1	16.7	13.4	11.1	9.2	8.1	7.4	6.7	6.1	
15	0.21	27	15.6	12.5	10.4	8.9	7.8	6.2	5.2	4.5	3.9	3.5	3.1	2.8	
20	0.25	32	18.6	14.9	12.4	10.6	9.3	7.4	6.2	5.3	4.6	4.1	3.7	3.4	
30	0.30	38	22	17.8	14.9	12.7	11.1	8.9	7.4	6.4	5.6	5.0	4.5	4.1	
40	0.35	45	26	21	17.3	14.9	13.0	10.4	8.7	7.4	6.5	5.8	5.2	4.7	
50	0.39	50	29	23	19.3	16.5	14.5	11.6	9.7	8.3	7.2	6.4	5.8	5.3	
60	0.43	55	32	26	21	18.2	16.0	12.8	10.6	9.1	8.0	7.1	6.4	5.8	
75	0.48	61	36	29	24	21	18.2	14.3	11.9	10.2	8.9	7.9	7.1	6.5	
90	0.53	68	39	31	26	22	19.2	15.7	13.1	11.2	9.8	8.7	7.9	7.2	
15	0.24	31	17.8	14.3	11.9	10.2	8.9	7.1	5.9	5.1	4.5	4.0	3.6	3.2	
20	0.28	36	21	16.6	13.9	11.9	10.4	8.3	6.9	5.9	5.2	4.6	4.2	3.8	
30	0.35	45	26	21	17.3	14.9	13.0	10.4	8.7	7.4	6.5	5.8	5.2	4.7	
40	0.40	51	30	24	19.8	17.0	14.9	11.9	9.9	8.5	7.4	6.6	5.9	5.4	
50	0.45	58	33	27	22	19.1	16.7	13.4	11.1	9.5	8.4	7.4	6.7	6.1	
60	0.49	63	36	29	24	21	18.2	14.6	12.1	10.4	9.1	8.1	7.3	6.6	
75	0.55	70	41	33	27	22	19.2	16.3	13.6	11.7	10.2	9.1	8.2	7.4	
90	0.60	77	45	36	30	25	22	17.8	14.9	12.7	11.1	9.9	8.9	8.1	
15	0.31	40	23	18.4	15.3	13.2	11.5	9.2	7.7	6.6	5.8	5.1	4.6	4.2	
20	0.35	45	26	21	17.3	14.9	13.0	10.4	8.7	7.4	6.5	5.8	5.2	4.7	
30	0.43	55	32	26	21	18.2	16.0	12.8	10.6	9.1	8.0	7.1	6.4	5.8	
40	0.50	64	37	30	25	21	18.6	14.9	12.4	10.6	9.3	8.3	7.4	6.8	
50	0.56	72	42	33	28	24	21	18.2	14.6	12.1	10.4	9.2	8.3	7.6	
60	0.61	78	45	36	30	26	23	18.1	15.1	12.9	11.3	10.1	9.1	8.2	
75	0.68	87	50	40	34	29	25	20	16.8	14.4	12.6	11.2	10.1	9.2	
90	0.75	96	56	45	37	32	28	22	18.6	15.9	13.9	12.4	11.1	10.1	
15	0.37	47	27	22	18.3	15.7	13.7	11.0	9.2	7.8	6.9	6.1	5.5	5.0	
20	0.42	54	31	25	21	17.8	15.6	12.5	10.4	8.9	7.8	6.9	6.2	5.7	
30	0.52	67	39	31	26	22	19.3	15.4	12.9	11.0	9.7	8.6	7.7	7.0	
40	0.60	77	45	36	30	25	21	17.8	14.6	12.1	10.4	9.0	8.0	7.3	
50	0.67	86	50	40	33	28	25	17.9	16.6	14.2	12.4	11.1	9.9	9.0	
60	0.73	93	54	43	36	31	27	22	18.1	15.5	13.6	12.0	10.8	9.9	
75	0.82	105	61	49	41	35	30	24	20	17.4	15.2	13.5	12.2	11.1	
90	0.90	115	67	53	45	38	33	27	22	19.1	16.7	14.9	13.4	12.2	
15	0.49	63	36	29	24	21	18.2	14.6	12.1	10.4	9.1	8.1	7.3	6.6	
20	0.57	73	42	34	28	24	21	16.9	14.1	12.1	10.6	9.4	8.5	7.7	
30	0.69	88	51	41	34	29	26	20	17.1	14.6	12.8	11.4	10.2	9.3	
40	0.80	102	59	48	40	34	30	24	19.8	17.0	14.9	13.2	11.9	10.8	
50	0.89	114	66	53	44	38	33	26	22	18.9	16.5	14.7	13.2	12.0	
60	0.98	125	73	58	49	42	36	29	24	21	18.2	16.2	14.6	13.2	
75	1.10	141	82	65	54	47	41	33	27	23	20	18.2	16.3	14.9	
90	1.20	154	89	71	59	51	45	36	30	25	22	19.8	17.8	16.2	
15	0.61	78	45	36	30	26	23	18.1	15.1	12.9	11.3	10.1	9.1	8.2	
20	0.71	91	53	42	35	30	26	21	17.6	15.1	13.2	11.7	10.5	9.6	
30	0.87	111	65	52	43	37	32	26	22	18.5	16.1	14.4	12.9	11.7	
40	1.00	128	74	59	50	42	37	30	25	21	18.6	16.5	14.9	13.5	
50	1.12	143	83	67	55	48	42	33	28	24	21	18.5	16.6	15.1	
60	1.22	156	91	72	60	52	45	36	30	26	23	20	18.1	16.5	
75	1.37	175	102	81	68	58	51	41	34	29	25	23	20	18.5	
90	1.50	192	111	89	74	64	56	45	37	32	28	25	22	20	
15	0.73	93	54	43	36	31	27	22	18.1	15.5	13.6	12.0	10.8	9.9	
20	0.85	109	63	50	42	36	32	25	22	18.0	15.8	14.0	12.6	11.5	
30	1.04	133	77	62	51	44	39	31	26	22	19.3	17.2	15.4	14.0	
40	1.20	154	89	71	59	51	45	36	30	25	22	19.8	17.8	16.2	
50	1.34	172	99	80	66	57	50	40	33	28	25	22	19.9	18.1	
60	1.47	188	109	87	73	62	55	44	36	31	27	24	22	19.8	
75	1.64	210	122	97	81	70	61	49	41	35	30	27	24	22	
90	1.85	240	144	107	89	76	67	55	45	38	33	30	28	24	
15	0.92	118	68	55	46	39	34	27	23	19.5	17.1	15.2	13.7	12.4	







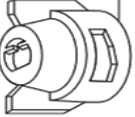

UNIVERSAL APPLICATION RATE CHART FOR 30" TIP SPACING

TIP CAPACITY	LIQUID PRESSURE IN PSI	CAPACITY ONE TIP IN GPM	CAPACITY ONE TIP IN OZ/MIN	GALLONS PER ACRE -- 30" SPRAY TIP SPACING												
				4 MPH	5 MPH	6 MPH	7 MPH	8 MPH	10 MPH	12 MPH	14 MPH	16 MPH	18 MPH	20 MPH	22 MPH	
01	15	0.061	7.8	3.0	2.4	2.0	1.7	1.5	1.2	1.0	0.86	0.75	0.67	0.60	0.55	
	20	0.071	9.1	3.5	2.8	2.3	2.0	1.8	1.4	1.2	1.0	0.88	0.78	0.70	0.64	
	30	0.087	11	4.3	3.4	2.9	2.5	2.2	1.7	1.4	1.2	1.1	0.96	0.86	0.78	
	40	0.10	13	5.0	4.0	3.3	2.8	2.5	2.0	1.7	1.4	1.2	1.1	0.99	0.90	
	50	0.11	14	5.4	4.4	3.6	3.1	2.7	2.2	1.8	1.6	1.4	1.2	1.1	0.99	
	60	0.12	15	5.9	4.8	4.0	3.4	3.0	2.4	2.0	1.7	1.5	1.3	1.2	1.1	
015	75	0.14	18	6.9	5.5	4.6	4.0	3.5	2.8	2.3	2.0	1.7	1.5	1.4	1.3	
	90	0.15	19	7.4	5.9	5.0	4.2	3.7	3.0	2.5	2.1	1.9	1.7	1.5	1.4	
	15	0.092	12	4.6	3.6	3.0	2.6	2.3	1.8	1.5	1.3	1.1	1.0	0.9	0.8	
	20	0.11	14	5.4	4.4	3.6	3.1	2.7	2.2	1.8	1.6	1.4	1.2	1.1	1.0	
	30	0.13	17	6.4	5.1	4.3	3.7	3.2	2.6	2.1	1.8	1.6	1.4	1.3	1.2	
	40	0.15	19	7.4	5.9	5.0	4.2	3.7	3.0	2.5	2.1	1.9	1.7	1.5	1.4	
02	50	0.17	22	8.4	6.7	5.6	4.8	4.2	3.4	2.8	2.4	2.1	1.9	1.7	1.5	
	60	0.18	23	8.9	7.1	5.9	5.1	4.5	3.6	3.0	2.5	2.2	2.0	1.8	1.6	
	75	0.21	27	10.4	8.3	6.9	5.9	5.2	4.2	3.5	3.0	2.6	2.3	2.1	1.9	
	90	0.22	29	11.4	9.1	7.6	6.5	5.7	4.6	3.8	3.3	2.8	2.5	2.3	2.1	
	15	0.12	15	5.9	4.8	4.0	3.4	3.0	2.4	2.0	1.7	1.5	1.3	1.2	1.1	
	20	0.14	18	6.9	5.5	4.6	4.0	3.5	2.8	2.3	2.0	1.7	1.5	1.4	1.3	
025	30	0.17	22	8.4	6.7	5.6	4.8	4.2	3.4	2.8	2.4	2.1	1.9	1.7	1.5	
	40	0.20	26	9.9	7.9	6.6	5.7	5.0	4.0	3.3	2.8	2.5	2.2	2.0	1.8	
	50	0.22	28	10.9	8.7	7.3	6.2	5.4	4.4	3.6	3.1	2.7	2.4	2.2	2.0	
	60	0.24	31	11.9	9.5	7.9	6.8	5.9	4.8	4.0	3.4	3.0	2.6	2.4	2.2	
	75	0.27	35	13.4	10.7	8.9	7.6	6.7	5.3	4.5	3.8	3.3	3.0	2.7	2.4	
	90	0.30	38	14.9	11.9	9.9	8.5	7.4	5.9	5.0	4.2	3.7	3.3	3.0	2.7	
03	15	0.15	19	7.4	5.9	5.0	4.2	3.7	3.0	2.5	2.1	1.9	1.7	1.5	1.4	
	20	0.18	23	8.9	7.1	5.9	5.1	4.5	3.6	3.0	2.5	2.2	2.0	1.8	1.6	
	30	0.22	28	10.9	8.7	7.3	6.2	5.4	4.4	3.6	3.1	2.7	2.4	2.2	2.0	
	40	0.25	32	12.4	9.9	8.3	7.1	6.2	5.0	4.1	3.5	3.1	2.8	2.5	2.3	
	50	0.28	36	13.9	11.1	9.2	7.9	6.9	5.5	4.6	4.0	3.5	3.1	2.8	2.5	
	60	0.31	40	15.3	12.3	10.2	8.8	7.7	6.1	5.1	4.4	3.7	3.3	3.0	2.7	
035	75	0.34	44	16.8	13.5	11.2	9.6	8.4	6.7	5.6	4.8	4.2	3.7	3.4	3.1	
	90	0.38	49	18.8	15.0	12.5	10.7	9.4	7.5	6.3	5.4	4.7	4.2	3.8	3.4	
	15	0.18	23	8.9	7.1	5.9	5.1	4.5	3.6	3.0	2.5	2.2	2.0	1.8	1.6	
	20	0.21	27	10.4	8.3	6.9	5.9	5.2	4.2	3.5	3.0	2.6	2.3	2.1	1.9	
	30	0.26	33	12.9	10.3	8.6	7.4	6.4	5.1	4.3	3.7	3.2	2.9	2.6	2.3	
	40	0.30	38	14.9	11.9	9.9	8.5	7.4	5.9	5.0	4.2	3.7	3.3	3.0	2.7	
04	50	0.34	44	16.8	13.5	11.2	9.6	8.4	6.7	5.6	4.8	4.2	3.7	3.4	3.1	
	60	0.37	47	18.3	14.7	12.2	10.5	9.2	7.3	6.1	5.2	4.6	4.1	3.7	3.3	
	75	0.41	52	20	16.2	13.5	11.6	10.1	8.1	6.8	5.8	5.1	4.5	4.1	3.7	
	90	0.45	58	22	17.8	14.9	12.7	11.1	8.9	7.4	6.4	5.6	5.0	4.5	4.1	
	15	0.21	27	10.4	8.3	6.9	5.9	5.2	4.2	3.5	3.0	2.6	2.3	2.1	1.9	
	20	0.25	32	12.4	9.9	8.3	7.1	6.2	5.0	4.1	3.5	3.1	2.8	2.5	2.3	
045	30	0.30	38	14.9	11.9	9.9	8.5	7.4	5.9	5.0	4.2	3.7	3.3	3.0	2.7	
	40	0.35	45	17.3	13.9	11.6	9.9	8.7	6.9	5.8	5.0	4.3	3.9	3.5	3.2	
	50	0.39	50	19.3	15.4	12.9	11.0	9.7	7.7	6.4	5.5	4.8	4.3	3.9	3.5	
	60	0.43	55	21	17.0	14.2	12.2	10.6	8.5	7.1	6.1	5.3	4.7	4.3	3.9	
	75	0.48	61	24	19.0	15.8	13.6	11.9	9.5	7.9	6.8	5.9	5.3	4.8	4.3	
	90	0.53	68	26	21	17.5	15.0	13.1	10.5	8.7	7.5	6.6	5.8	5.2	4.8	
05	15	0.24	31	11.9	9.5	7.9	6.8	5.9	4.8	4.0	3.4	3.0	2.6	2.4	2.2	
	20	0.28	36	13.9	11.1	9.2	7.9	6.9	5.5	4.6	4.0	3.5	3.1	2.8	2.5	
	30	0.35	45	17.3	13.9	11.6	9.9	8.7	6.9	5.8	5.0	4.3	3.9	3.5	3.2	
	40	0.40	51	19.8	15.8	13.2	11.3	9.9	7.9	6.6	5.7	5.0	4.4	4.0	3.6	
	50	0.45	58	22	17.8	14.9	12.7	11.1	8.9	7.4	6.4	5.6	5.0	4.5	4.1	
	60	0.49	63	24	19.4	16.2	13.9	12.1	9.7	8.1	6.9	6.1	5.4	4.9	4.4	
06	75	0.55	70	27	22	18.2	15.6	13.6	10.9	9.1	7.8	6.8	6.1	5.4	5.0	
	90	0.60	77	30	24	19.8	17.0	14.9	11.9	9.9	8.5	7.4	6.6	5.9	5.4	
	15	0.31	40	15.3	12.3	10.2	8.8	7.7	6.1	5.1	4.4	3.8	3.4	3.1	2.8	
	20	0.35	45	17.3	13.9	11.6	9.9	8.7	6.9	5.8	5.0	4.3	3.9	3.5	3.2	
	30	0.43	55	21	17.0	14.2	12.2	10.6	8.5	7.1	6.1	5.3	4.7	4.3	3.9	
	40	0.50	64	25	19.8	16.5	14.1	12.4	9.9	8.3	7.1	6.2	5.5	5.0	4.5	
065	50	0.56	72	28	22	18.5	15.8	13.9	11.1	9.2	7.9	6.9	6.2	5.5	5.0	
	60	0.61	78	30	24	20	17.3	15.1	12.1	10.1	8.6	7.5	6.7	6.0	5.5	
	75	0.68	87	34	27	22	19.2	16.8	13.5	11.2	9.6	8.4	7.5	6.7	6.1	
	90	0.75	97	37	30	25	21	18.6	14.9	12.4	10.6	9.3	8.3	7.4	6.8	
	15	0.47	47	18.3	14.7	12.2	10.5	9.2	7.3	6.1	5.2	4.6	4.1	3.7	3.3	
	20	0.42	54	21	16.6	13.9	11.9	10.4	8.3	6.9	5.9	5.2	4.6	4.2	3.8	
07	30	0.52	67	26	21	17.2	14.7	12.9	10.3	8.6	7.4	6.4	5.7	5.1	4.7	
	40	0.60	77	30	24	19.8	17.0	14.9	11.9	9.9	8.5	7.4	6.6	5.9	5.4	
	50	0.67	86	33	27	22	19.0	16.6	13.3	11.1	9.5	8.3	7.4	6.6	6.0	
	60	0.73	93	36	29	24	21	18.1	14.5	12.0	10.3	9.0	8.0	7.2	6.6	
	75	0.82	105	41	32	27	23	20	16.2	13.5	11.6	10.1	9.0	8.1	7.4	
	90	0.90	115	45	36	30	25	22	17.8	14.9	12.7	11.1	9.9	8.9	8.1	
08	15	0.49	63	24	19.4	16.2	13.9	12.1	9.7	8.1	6.9	6.1	5.4	4.9	4.4	
	20	0.57	73	28	23	18.8	16.1	14.1	11.3	9.4	8.1	7.1	6.3	5.6	5.1	
	30	0.69	88	34	27	23	19.5	17.1	13.7	11.4	9.8	8.5	7.6	6.8	6.2	
	40	0.80	102	40	32	26	23	19.8	15.8	13.2	11.3	9.9	8.8	7.9	7.2	
	50	0.89	114	44	35	29	25	22	17.6	14.7	12.6	11.0	9.8	8.8	8.0	
	60	0.98	125	49	39	32	28	24	19.4	16.2	13.9	12.1	10.8	9.7	8.8	
09	75	1.10	141	54	44	36	31	27	22	18.2	15.6	13.6	12.1	10.9	9.9	
	90	1.20	154	59	48	40	34	30	24	19.8	17.0	14.9	13.2	11.9	10.8	
	15	0.61	78	30	24	20	17.3	15.1	12.1	10.1	8.6	7.5	6.7	6.0	5.5	
	20	0.71	91	35	28	23	20	17.6	14.1	11.7	10.0	8.8	7.8	7.0	6.4	
	30	0.87	111	43	34	29	25	22	17.2	14.4	12.3	10.8	9.6	8.6	7.8	
	40	1.00	128	50	40	33	28	25	19.8	16.5	14.1	12.4	11.0	9.9	9.0	
10	50	1.12	143	55	44	37	32	28	22	18.5	15.8	13.9	12.3	11.1	10.1	
	60	1.22	156	60	48	40	35	30	24	20	17.3	15.1	13.4	12.1	11.0	
	75	1.37	175	68	54	45	39	34	27	23	19.4	17.0	15.1	13.6	12.3	
	90	1.50	192	74	59	50	42	37	30	25	21	18.6	16.5	14.9	13.5	
	15	0.73	93	36	29	24	21	18.1	14.5	12.0	10.3	9.0	8.0	7.2	6.6	
	20	0.85	109	42	34	28	24	21	16.8	14.0	12.0	10.5	9.4	8.4	7.7	
12	30	1.04	133	51	41	34	29	26	21	17.2	14.7	12.9	11.4	10.3	9.4	
	40	1.20	154	59	48	40	34	30	24	19.8	17.0	14.9	13.2	11.9	10.8	
	50	1.34	172	66	53	44	38	33	27	22	19.0	16.6	14.7	13.3	12.1	
	60	1.47	188	73	58	49	42	36	29	24	21	18.2	16.2	14.6	13.2	
	75	1.64	210	81	65	54	46	41	32	27	23	20				

Quick TeeJet® CAPS (For Pressures up to 300 PSI/20 bar)

 <p>Quick TeeJet Cap and Seal Gasket</p> <p>Quick TeeJet Cap</p> <p>Seal Gasket</p> <p>CP19438-EPR (EPDM Standard) CP19438-VI (Viton Optional)</p>	<p>Quick TeeJet Cap</p> <p>BLACK 1 WHITE 2 RED 3 BLUE 4</p>	<p>Quick TeeJet Cap</p> <p>GREEN 5 YELLOW 6 BROWN 7 ORANGE 8 VIOLET 10</p>	<p>* Specify Color Code (see chart). Unless otherwise specified, a Yellow (6) Cap will be supplied.</p>

	For use with spray tips (300 psi / 20 bar rating)	Part No	Description	Price
	<p>TeeJet® Flat Spray Tips (Smaller Capacities)</p> <p>Standard -0067 thru -08 XR -01 thru -08 Turbo TwinJet®</p>	CP114440A-*-CE	Cap only	\$1.10
	<p>AIXR TeeJet® DG TeeJet® Turbo TeeJet® OC TeeJet®</p>	114441A-*-CELR	Cap and seat gasket set	1.35
	<p>TeeJet® Flat Spray Tips (Larger Capacities)</p> <p>Standard -10 thru -20 XR -10 thru -15</p>	CP25609-*-NY	Cap only	1.10
		25610-*-NYR	Cap and seat gasket set	1.55
	<p>TJ TwinJet® AI Turbo TwinJet® DG TwinJet® SJ-3 StreamJet®</p> <p>AI TeeJet® & AIUB TeeJet® Turbo TeeJet® Induction</p>	CP114442A-*-CE	Cap only	1.10
		114443A-*-CELR	Cap and seat gasket set	1.55
	<p>TK FloodJet® FL FullJet® TX ConeJet®</p>	CP114444A-*-CE	Cap only	1.10
	<p>TG Full Cone Hose Shank AITXA</p>	114445A-*-CELR	Cap and seat gasket set	1.55
 <p>ⓑ (¼ only)</p>	<p>Adapter Cap with EPDM Seat Gasket, Black</p>	QJ4676-1/8-NYR	Quick TeeJet outlet adapter	3.25
		QJ(B)4676-1/4-NYR	Quick TeeJet outlet adapter	3.25
	<p>Adapter Cap 1/4TTJ with EPDM Seat Gasket, Black</p>	QJ4676-90-1/4-NYR	Quick TeeJet outlet adapter, 90°	5.80
		QJ4676-45-1/4-NYR	Quick TeeJet outlet adapter, 45°	5.80
	<p>Shut-Off Cap with EPDM Seat Gasket, Black</p>	114447A-*-CELR	Quick TeeJet shut-off cap and seat gasket set	2.85

ⓑ Also available with BSPT connection.



605-342-7644 ~ www.warneusa.com

BOOMLESS NOZZLES

WARNE'S BOOM BLASTER BOOMLESS NOZZLES

Features

- Straight through nozzle design means you do not need a left or right nozzle
- Solid stainless steel means superior pattern and distribution • Nothing to wear out



Great For

- Roadside • Noxious weed control
- Handgun work

Models

- W2125 ~ \$113.00
- W2140 ~ \$123.00
- W2187 ~ \$139.00

1/2" and 3/4" diaphragm check valves are available to boomless nozzle assemblies \$112.98



BOOMINATOR Boomless Spray Nozzles

Benefits: • Produce a superior spray pattern with even distribution over the entire pattern • Produce a heavy droplet pattern for minimal, drift and better crop penetration • Can easily spray around obstacles and over uneven terrain

Applications: • Noxious weed control • De-icing on roads, bridges, sidewalks, runways and parking lots

• Dust suppression • Lawn, turf and nursery applications • Grass fire fighting • Orchard, vineyard and vegetable spraying • Ponds, lakes, canals for aquatic pest and weed control • Insect control

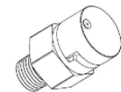

1160L	\$113
1160R	113
1165L	113
1165R	113
1250FS	\$139
1250RS	139
1250L	113
1250R	113
1253L	113
1253R	113
1255L	113
1255R	113

1400FM	\$149
1400FS	149
1400FSS	149
1400RS	123
1400L	123
1400R	123
1404L	123
1404R	123
1406L	123
1406R	123

1870FL	\$159
1870FM	159
1870FS	159
1870FSS	159
1870L	133
1870R	133
1871L	133
1871R	133
1876L	133
1876R	133

2650RS	\$190
2650FL	190
2650FS	190
2650L	190
2650R	190
2651L	190
2651R	190
3120RS	190
3120FL	190
3120FM	190
3120FS	190

3120L	\$167
3120R	167
3121L	167
3121R	167
3750FL	190
3750L	177
3750R	177
4370FL	\$190
4370RS	177
4370L	177
4370R	177

5000L	\$244
5000R	244
6250L	\$255
6250R	255

Abbreviations
L ~ Left
R ~ Right
FS ~ Full spray short
FM ~ Full spray medium
FL ~ Full spray low

Please call or check at warnechemical.com for complete spec sheet

BOOMINATOR ECONO SERIES

Designed for the occasional non-commercial user. Molded from celcon.

Model	PSI	GPM	Distance at 36"
1200 PSR & 1200 PSL	20	1.0	14'
	30	1.2	14'
	40	1.4	14'
1400 PSR & 1400 PSL	20	1.7	15'
	30	2.0	15'
	40	2.5	15'



Full Spray Models	
1200 PSS	\$23.90
1200 PS	23.90
1400 PS	29.88
1400 PL	32.00
1870 PL	36.00

Right and Left Models	
1200 PSR (right)	\$52.50
1200 PSL (left)	52.50
1400 PSR (right)	56.50
1400 PSL (left)	56.50

Model	PSI	GPM	Distance At 36"
1200 PSS	15	.9	6'
	20	1.0	6'
	25	1.1	6'
1200 PS	20	1.0	12'
	30	1.2	12'
	40	1.4	12'
1400PS	20	1.7	12'
	30	2.0	12'
	40	2.5	12'
1400PL	20	2.0	20'
	30	2.4	20'
	40	2.8	20'
1870PL	20	3.0	25'
	30	3.5	25'
	40	4.3	25'

BOOM BUSTER NOZZLES



- Machined from solid SS.
- Replaceable industrial grade nylon diffusers.
- Excellent pattern and distribution.
- Right-of-way nozzles spray beneath and slightly behind nozzle (add letter R on order).

Model	Price
120 Series	\$126.75
140 Series	137.75
180 Series	142.50
260 Series	157.25
370 Series	166.50
400 Series	174.00
500 Series	210.00

GPS GUIDANCE SYSTEMS



MATRIX[®] 908

- 8" screen • Durable metal case • Auto steering capable
- Section control capable • Variable rate application capable • SBAS, Terra Star, and RTK GPS signals ready

90-10006-ENS, KIT M908 NAV-L1-GLO-ENUS - \$2,825.00*

- 8" accuracy • No subscription fees
- Manual guidance, boom sense inlet
- Ready to accept subscription GPS signals for increased accuracy

90-10006-ENUS-NH + 45-10236 + 45-05381 - \$3,362.00*

- 8" accuracy • No subscription fees • Manual guidance
- Auto steering capable with Unipilot Pro Kit
91-05039 \$8,906.00*
- Auto section control with boom pilot, most kits (by brand)
90-02990 \$1,930.00*
- Ready to accept subscription GPS signals for increased accuracy.

90-10011-ENUS, KIT M908 ISO-L1-GLO-ENUS - \$3,842.00*

- Isobus display
- TeeJet CAN, ISOBUS CAN for advanced options
- Auto steering capable with Unipilot Pro Kit
91-05039 \$8,906.00*
- Auto section control with boom pilot, most kits (by brand)
90-02990 \$1,930.00*
- Rate control when tied to existing rate controller
- Ready to accept subscription GPS signals for increased accuracy
- Adapter cables available from MicroTrak

MATRIX[®] 430

Guidance simplified! The compact Matrix 430 is an easy to use, low cost, graphical guidance system ideal for first-time users. The full-color, touch screen display allows the operator to efficiently navigate fields with minimal skips and overlaps in coverage.



- Minimal setup needed before operating
- Boundary function allows for easy and precise measurement of field area
- Area counter measures and displays applied area throughout application
Guidance modes include Straight AB, Curved AB, Circle Pivot, and Last Pass
- Return-to-point feature allows operator to easily resume jobs
- Applied alert provides operator with audible alarm
- Optional RXA-30 antenna provides improved reception
- High contrast, full-color, 4.3" graphic touchscreen display provides superior visibility
- Quickly portable machine to machine

Kits

GD430-GLO-P-L Kit Matrix 430, GLONASS, patch antenna, US lighter connector	\$1,729*
GD430-GLO-R30-L Kit Matrix 430, GLONASS, RXA-30 antenna, US lighter connector	\$2,175*

Components

45-05775	Cable, power, direct to battery, 10'/3 m	\$134.30*
45-05970	Cable power speed boom sense	249.60*
60-10081	One set of 3 velcro strips	8.50*
65-05179	Metal mounting plate (requires 3 velcro strips)	14.60*
78-50190	Antenna, GPS patch L1 with GLONASS	298.00*
90-02720	Kit, RXA-30 antenna with 20'/6m cable	795.00*

RAM Ball Mounts

B201U	3" arm	\$31.50*	
B202U	2.5" round base	17.85*	
B231ZU	UTV bar mount	32.50*	
B238U	Diamond base	16.20*	

Other options available, please inquire

GPS Antenna Base - \$39.00*

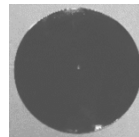

- Improved signal reception on fiberglass cabs
- Includes two-sided foam tape
- Powder coated finish

Inquire about GPS
mapping and reporting options

SPRAY APPLICATION CONTROL BOXES AND ELECTRONIC COMPONENTS

Texas Remcor 3-Switch Control Box

Features

- 3-boom switches
- Master control switch
- 6' cab harness
- 8' sprayer harness
- Pressure regulator switch with gauge



Accessories

Item #	Description	Price
1181	1/8" Tube FTG x 1/8" MPT	\$ 5.71
1182	1/8" Union/Coupler	8.25
2388	1/8" Gauge tube, 25' roll	69.55

Item #	Description	Price
Con.2460.WP.3	For electric ball valves	\$692.00
Con.RC1B.WP	For solenoid valves	561.70
Con.RC2.WP	For solenoid valves, without pressure control or gauge	371.90



Raven Repair Parts

Item #	Description	Price
063001	Butterfly valve, 3/4", CS203,103	\$194.50
16130A	Butterfly flanged valve, 1-1/2", Fits most Raven controllers and MicroTrak controllers	643.00

Switch Boxes for Solenoids and 12-Volt Pumps

6' lead to battery, 4' lead off 15' lead with detachable solenoid hookup.

- Single switch box - \$220.00*
- Double switch box - \$250.00*
- Triple switch box - \$290.00*
- Four switch box - \$330.00*

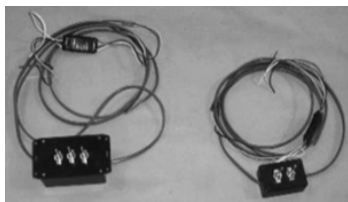

33-103237

120" wire, 2-pin connector, battery clips,
on/off rocker switch - \$17.80*

Electrical Wiring Components

Item #	Description	Price
31503	16-14 gauge ring terminal	\$.28 ea
31712	16-14 gauge male terminal	.50 ea
31713	16-14 gauge female terminal	.65 ea
31760	16-14 gauge butt connector	.35 ea
32760	12-10 gauge butt connector	.50 ea
33005	8 gauge ring terminal	1.35 ea
37120	Flat 2 connector, male, 14 ga	4.44 ea
37120-12	Flat 2 connector, male 12 ga	4.95 ea
37121	Flat 3 connector, male	4.85 ea
37122	Flat 4 connector, male	4.95 ea
37130	Flat 2 connector, female, 14 ga	4.44 ea
37130-12	Flat 2 connector, female, 12 ga	4.95 ea
37131	Flat 3 connector, female	4.85 ea
37132	Flat 4 connector, female	4.95 ea
37708	50-amp connector	7.85 ea
44224	50-amp toggle switch	15.85 ea
46330	30-amp breaker	7.65 ea
46550	50-amp breaker	7.65 ea
46877	30-amp surface mount marine rated circuit breaker	72.00 ea
BBL	Large switch box (4-5)	21.50 ea
MBL	Medium switch box (3-4)	17.20 ea
SBL	Small switch box (1-2)	9.85 ea
SJ12-3	12-3 jacketed cable	3.45 / ft
SJ12-4	12-4 trailer cable	4.25 / ft
SJ14-3	14-3 jacketed cable	2.73 / ft
SJ14-4	14-4 jacketed cable	3.45 / ft
WD12-2	12-2 jacketed cable	1.95 / ft
WD14-2	14-2 jacketed cable	1.55 / ft
WD8-2	8-2 jacketed cable	3.90 / ft
WPCONN	Weather pack connector	8.50 ea
WPADAP	Weather pack adapter for solenoids	7.20 ea

SPRAY APPLICATION COMPUTERS AND ELECTRONIC CONTROLS

RATEKING™ PLUS

Automatic Rate Controller
For Liquids



Flexible, powerful, automatic liquid rate control solution for agriculture, turf, and highway maintenance. Customizable monitoring options and advanced features let you manage your liquid applications with absolute peace-of-mind.

- Flow or pressure-based control
- Expanded PWM control capabilities
- Unique multi-function outputs to control on/off valves for Master, Relief, Flow Trigger, or Flush functions

01883 Unit without GPS Speed Sensor - **\$2,889.00***
Select an Astro GPS Speed Sensor from below

SPRAYMATE™ II

Automatic Rate Controller



Our lowest cost, fully automatic sprayer control. Includes 3/4" flowmeter, 1" servo valve, Hall effect flow sensor, mounting hardware, weatherproof connectors, and three boom switches. Automatically compensates for changing speed to maintain a pre-set application rate. Designed for use with electric boom switches.

- For liquid application
- On-the-go rate adjustment
- Application rate, flow rate, total flow, speed, distance and area per hour functions, plus two separate area counters
- Out-of-range warning light
- Lighted liquid crystal display, BriteKnob™ and panel lighting for night use

01171 Unit without GPS Speed Sensor - **\$2,061.00***
Select an Astro GPS Speed Sensor from below

FLOW-TRAK™ II Sprayer Monitor

Economical way to improve spraying accuracy

Includes 3/4" flowmeter, Hall effect speed and flow sensors, mounting hardware and weatherproof connectors.



Flow-Trak provides the information needed to keep your chemical application on track. Helps eliminate waste and achieve more consistent results.

- Large, easy-to-read liquid crystal display
- Lighted liquid crystal display, BriteKnob™ and panel lighting for night use
- Application rate, flow rate, total flow, speed, distance, and area per hour functions, plus two separate area counters
- Out-of-range warning light
- Push-button run/hold

01170 Unit without Speed Sensor - **\$1,438.00***

RoadMaster

Roadway products rate controller



- Use to regulate the flow of liquid de-icer, anti-icers, roadside spray products and dust control agents, turf herbicides, fungicides, insecticides, and fertilizers
- Selectable servo drive options
- Built-in BRA/AVL communications
- Extensive downloadable date list
- Blast switch
- Keylock switch.

#01590 **\$2,115.00**

Select a flow meter, servo valve and Astro GPS Speed Sensor from below

ASTRO GPS BASED SPEED SENSORS

Improve productivity and efficiency

- The Astro GPS based speed sensors are a direct replacement for magnetic wheel speed sensors or radar guns and can interface to most brands of monitors and controllers.
- The magnetic mount bracket is standard and allows for quick installation and easy transfer from one vehicle to another. Optional mount kits also available.



Astro II #01410 \$540.00*

Based on accurate, yet economical 1 HXZ GPS receiver

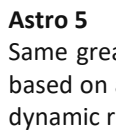

Astro 5 #01425 \$725.00*

Same great features as the Astro II but based on a 5 HZ GPS receiver for faster, dynamic response to speed changes



Micro-Trak Flow Meter Kits

FM750 01501 2 - 40 gpm **\$533.00***

FM10-100 01514 10 - 100 gpm **\$907.00***



Micro-Trak Replacement Servo Valve

1" NPT threads, fits most Micro-Trak units
19093 **\$440.00***



FOAM MARKING SYSTEM

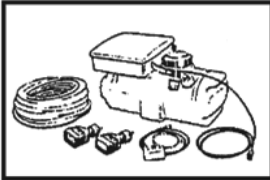

For spraying equipment,
no-till drill,
golf course sprayers

A ready-to-use compact 12-volt foam marker designed for dependable, low cost operation. The foamer comes complete to equip up to an 80' boom including R/L switch with 20' cable to foamer module. Unit features molded mounting lugs in bottom and strapping areas allowing easy installation. A 14-gallon foamer operates 2.5 to 3 hours on a fill at a cost of \$0.03 to \$0.04 per acre. Foam rates can be adjusted with replacement discharge orifices.



Units

500 FM006	6-gallon unit	\$1,030.00
500 FM014S	14-gallon twinline foamer	1,310.00
500 FM025S	25-gallon twinline foamer	1,355.00
	WC mounting bracket, custom	165.00
	Complete system installation	155.00

Replacement Parts

500 FMFC	Standard collector	\$16.50
500 FMFCL	High volume collector and hose	32.80
500 CAF	Compressor air filter	14.60
500 FMS	Collector sock, small	3.95
003 TL 025	Twinline hose, 100'	234.00
500 FM5A	Pickup tube assembly	22.00
500 FM5L	Collector sock, large	5.25
	Metering orifice for foam marker flow control (sizes 27,29,31,33,37,39,41,43)	4.15
500 FM5A	Y assembly	29.00
500 FM5PG	Gas air compressor	420.00
500 FM5CV	Check valve	16.95
500 FM5PC	Wiring harness with switch box	192.00
500 FM5SC	Secondary cable	33.50
500 FM5FG	Foam generator	38.75
500 FM5FGS	Twinline foam generator (does not include Y assembly)	38.75
250 22043	Texas Remcor 3-way twinline solenoid	149.20

Concentrates and Additives

	Enduron PSI High performance foam 100 to 1 concentration	4 x 1 Gallon	\$53.90* per gallon
	Pink Tracer Foam Dye One qt colors 300 to 600 gallons of foam solution. Works well on green crops and bare ground	12 x 1 Quart	\$39.85* per quart

SPRAY BOOMS AND ACCESSORIES



03DB12B	12' Boom, bare	\$290.00
03DB12	12' Boom, standard plumbing, 40" spacing	378.00
03DB18B	18' Boom, bare	415.00
03DB181	18' Boom, standard plumbing, 40" spacing	533.00

Above booms are 3-section, spring loaded, 1-1/4" square tubing, standard Spraying Systems plumbing, rear fold. Does not include mounting bracket.

500 ATV	Bracket set, R/L receiver set	\$ 88.00*
500 003	L boom mount for above receiver, set of 2	58.00*
500 ATV	80" boom	112.25*
500 ATV	80" boom with tips	125.00*
DB21	21' folding boom, no plumbing	957.00*
DB21	21' folding boom with tips	1,547.00*

Larger spray booms available, please inquire.

Receiver Hitch Booms

2" Receiver Hitch Boom

- 80" vertical telescoping boom, bare
RHB80 - \$310.00*
- 80" vertical telescoping boom, plumbed
with four nozzle bodies (does not include nozzles)
RHB80P - \$395.00*



2" Receiver Hitch Boom, Less Nozzles

- Vertical telescoping, bare
RHBB - \$273.00*
- Vertical telescoping, with boomless nozzle
body plumbing (does not include nozzles)
RHBBP - \$360.00*

Boominator Bracket

For standard 55, 60, 75 and 100 UTV sprayers
\$34.00*



For Ultra Low 55 and 75-gallon UTV sprayers
\$32.00*

Hand Wheel



Model 902-015 \$9.00 *

- 10 mm
- Use on boom setting for UTV sprayers

Flatbed Mounted Truck Ladder

\$119.00*

- Hinges to lay flat
- Easily retro fitted to flatbed truck or trailer



BACKPACK SPRAYERS

JACTO BACKPACK SPRAYERS

**Commercial 4-Gallon Capacity Unit
CD 400 \$210.00**

- 4-gallon capacity • Double piston pump
- Reversible pump lever, right and left
- No fittings to leak out bottom of tank
- Brass wand



**Occasional Use 3-Gallon Capacity Unit
XP312 \$124.00**

- 3-gallon capacity • Adjustable cone nozzle
- High performance piston pump
- Vented tank lid with basket strainer
- Adjustable padded straps



FLOWZONE BACKPACK SPRAYERS

**Rechargeable Electric 4-Gallon Capacity Unit
Typhoon 3 \$314.99**

The most comfortable and advanced backpack sprayer ever.

- Removable 18V battery and backpack style padded shoulder straps with lower lumbar support
- Spray time 60+ gallons per battery charge
- Flow rate: 0.47 - 0.77 gpm
- Viton seals
- Applications include weed spraying, tree/shrub spraying, pest control, noxious weed spraying etc



**Rechargeable Electric 1-Gallon Capacity Unit
Storm Zero \$225.00**
Additional 1-Gallon Swap Tank, Hand Held \$53.60



- Ergonomic inline spray handle • Focus on spraying, not pumping • 4-way adjustable brass nozzle • Optional easy swap gallon tank • Easy access battery • Low flow capability to target areas with precision accuracy • Ideal applications include pest control, shrub beds, turf weeds, greenhouse, etc

CHAPIN SPRAYERS

General Purpose

- Pressure relief • Folding handle

G1000P	1-gallon	\$45.10
G2000P	2-gallon	49.50

Replacement Parts Available



Lawn and Garden

20000	1-gallon, adjustable tip	\$24.20
20002	2-gallon, adjustable tip	30.80

SureSpray General Purpose

10000	1/2-gallon, adjustable tip	\$37.25
-------	----------------------------	---------



Trigger

1105	32-ounce, sprays "upside down"	\$9.55
------	--------------------------------	--------

Truck Mounted Hand Sprayer Holder

- Safely and securely holds hand sprayer • Avoid lost and damaged hand sprayers • Holds sprayers up to 9" diameter



\$58.00 each

Sprayer sold separately



ADJUSTABLE MOUNT

5050L-B \$97.50* each

Works great for backpack sprayers, gas cans, chemical jugs, etc. Max width 20.5".



BACKPACK BRACKET

\$163.00

Includes 5050L-B mount and steel base for truck bed or flatbed mounting. Backpack sold separately.

CHAPIN 24V BATTERY BACKPACK SPRAYER

Model #63924 \$259.00

- 4-gallon capacity
- One charge sprays up to 50 gallons
- Powered by 24v Li-ion rechargeable battery (charger included)
- Weighs 39% less than competitive units (9.8 lbs vs 16 lbs)
- Sprays at a constant 35 psi
- Equipped with viton seals and gaskets in key areas
- Built-in carrying handle makes cap removal easy and carrying the unit a breeze
- 6" wide mouth cap for easy filling
- Uses the same 6800 Pro Series tank assembly, filters and shutoff CD



Battery and battery charger kit - \$74.00

TANKS

Horizontal Tanks and Cradles – ACE



Tank P/N	Gal	Dimensions	Fitting	Lid	Tank	Cradle P/N	Cradle
HZ0055-23	55	23 x 38	3/4	5"	\$204.00	HZ0055-C	\$ 122.00
HZ0075-24	75	25 x 47	3/4	5"	245.00	HZ0075-C	202.00
HZ0110-30	110	30 x 44	1-1/4	8"	336.00	HZ0110-C	245.00
HZ0150-30	150	30 x 57	3/4 x 1-1/4	8"	413.00	HZ0153-C	351.00
HZ0150-32	150	32 x 52	3/4 x 1-1/4	8"	413.00	HZ0150-C	342.00
HZ0200-38	200	38 x 50	3/4 x 1-1/4	8"	491.00	HZ0238-C	474.00
HZ0200-32	200	32 x 58	3/4 x 1-1/4	8"	491.00	HZ0232-C	498.00
HZ0300-38	300	38 x 76	3/4 x 1-1/4	8"	629.00	HZ0300-C	573.00
HZ0500-48	500	48 x 79	3/4 x 1-1/4	8"	856.00	HZ0500-C	698.00

Horizontal Liquid Transport Tanks – ACE



Tank P/N	Gal	Dimensions	# Bands	Tank	Hoop P/N	Hoop
FS0035-18	35	18 x 34	2	\$ 141.00	FS0035SP	\$33.00/set
FS0065-24	65	24 x 39	2	267.00	FS0065SP	35.00/set
FS0125-32	125	32 x 40	2	443.00	FS0125SP	73.00/set
FS0225-38	225	38 x 52	2	593.00	FS0225SP	89.00/set
FS0335-44	335	44 x 56	2	711.00	FS1335SP	102.00/set
FS0535-48	535	48 x 78	2	1,077.00	FS0535SP	107.00/set
FS0735-48	735	48 x 103	3	1,488.00	FS048SP	363.00/set
FS1300-DW	1300	62 x 114	3	2,385.00	FS062-HP-1300	388.85/set

Manufacturer warranty for above tanks not valid without purchase of recommended hoops.

Elliptical Leg Tanks Free Standing



Tank P/N	Gal	Dimensions	# Bands	Tank	Hoop P/N	Hoop
FS0510	510	57 x 80 x 39	3	\$ 988.00	FS0510HP	\$355.00
FS1035	1035	79 x 90 x 52	3	1,661.00	FS1035HP	433.00
FS1610-78	1610	78 x 139 x 56	4	3,365.00	FS1610HP	633.00*
FS2350-88	2350	88 x 146 x 63	4	5,187.00	FS2350HP	1,153.00*
FS2750-88	2750	88 x 146 x 70	4	6,311.00	FS2750HP	1,319.00*
FS3250-88	3250	88 x 146 x 79	4	6,522.00	FS3250HP	1,444.00*
FS3250-88BLK	3250	88 x 146 x 79	4	6,625.00	FS3250HP	1,444.00*
THF03200BLK Pin Mount Tank	3200	97 x 145 x 79	0	8,890.00	Pin Kit AP204	240.00*

Ladder and hoops sold separately

Manufacturer warranty for above tanks not valid without purchase of recommended hoops. * baffled tanks

Elliptical Tanks and Cradles – ACE



Tank P/N	Gal	Dimensions	Tank	Cradle P/N	Cradle
HE0200-41	200	41 x 66 x 26	\$ 615.00	HE0200-C	\$568.00
EO0300-48	300	48 x 70 x 30	778.00	HE0300-C	648.00
HE0400-57	400	57 x 70 x 36	864.00	HE0400-C	757.00
HE0500-57	500	57 x 82 x 36	1,060.00	HE0500-C	875.00
HE0750-69	750	69 x 89 x 42	1,446.00	HE0750-C	1,420.00
HE1000-78	1000	78 x 90 x 49	1,800.00	HE1000-C	1,940.00

Pickup Tanks Round



Tank P/N	Gal	Dimensions	Price
PU 0200-52	200	52 x 30	\$379.00
PU 0350-62	350	62 x 34	597.00
PU 0450-62	450	62 x 41	653.00
PU 0205-52	205	52 x 52 x 26	502.00
PU 0305-60	305	60 x 58 x 30	653.00

TANKS



Vertical Tanks

Part #	Gallons/Description	Dimensions	Price
VT55	55-gallon	20 x 47	\$179.00
VT65	65-gallon	23 x 42	205.00
VT110	110-gallon	32 x 41	310.00
VT300-42	300-gallon	42 x 55	547.00
VT550	550-gallon	52 x 66	799.00
VT1000-64	1000-gallon	64 x 81	1,546.00
VT1050	1050-gallon	86 x 54	1,108.00
VT1350	1350-gallon	86 x 65	1,302.00
VT1500	1500-gallon	86 x 69	1,472.00
VT1500B	1500-gallon, black	86 x 69	1,492.00
VT1650	1650-gallon	86 x 74	1,532.00
VT2500	2500-gallon	91 x 103	2,377.00
VT3000	3000-gallon	91 x 120	2,944.00
VT3000	3000-gallon, black	91 x 120	3,004.00
VT5150	5150-gallon	102 x 161	6,884.00
VT6250	6250-gallon	102 x 194	7,690.00
VT8000-120	8000-gallon	120 x 180	9,910.00
VT10500-2500	10,500-gallon	142 x 177	12,960.00



Low Profile Tanks

Part #	Gallons	Dimensions	Price
LP1275	1275-gallon	84W x 36 x 126L	\$3,032.00
LP1600	1600-gallon	84W x 42 x 126L	3,490.00
2400Box	2400-gallon	90W x 53 x 150L	4,961.00

Have flat bottoms and will not completely drain

Free Standing Utility Tank

- Will fit through doorway
- Withdrawal fitting needs to be added



Part #	Gallons	Dimensions	Price
SP0250-UT	250-gallon	29W x 62L x 42H	\$673.00
SP0300-UT	300-gallon	29W x 62L x 52H	840.00
SP0400-UT	400-gallon	29W x 62L x 66H	1,098.00

Specialty Tanks

Part #	Gallons / Description	Dimensions	Price
RT3	Clean water	12 x 7 x 14	\$ 99.00
SPBM05-SQ5	5-gallon rinse tank	11 x 11 x 18	79.00
SP0006-5N	6-gallon, 5" lid	12 x 15 x 8	81.00
SP0008-VM	Loaf	12 x 16 x 17	99.00
SP0012-VM	Loaf	12 x 16 x 22	103.00
SB00015	15-gallon, spot	14 x 14 x 31	62.00
SB00025	25-gallon, spot	18 x 17 x 36	80.00
PCO50	50-gallon, PCO	19 x 38 x 23	241.00
PCO100	100-gallon, PCO	30 x 38 x 29	383.00
PCO100	100-gallon, PCO w/sump	30 x 38 x 29	383.00
PCO200	200-gallon, PCO	37 x 48 x 38	583.00
PCO300	300-gallon, PCO, baffle	37 x 69 x 40	1,180.00
PCO300B	300-gallon, PCO, baffle, black	37 x 69 x 40	1,203.00
SB00040SW	40-gallon, blow mold		124.00
SB00060SW	60-gallon, blow mold		161.00

Pin Mount Horizontal Leg Tank



Part #	Gallons	Dimensions	Price
THF03200	3200	Black	\$8,890.00
AP204	Pin kit	3200-gallon	240.00

Cone Bottom Inductors

Cone-shaped tank assemblies are to be used on the suction side of the transfer pump for inducting chemicals and fertilizer into sprayer tanks. Includes 2" valve and tee. 15-gallon units can be shipped UPS.

Part #	Size	Price
WC-ID 15	15	\$337.00
WC-ID 30	30	403.00
WC-ID 55	55	481.00
WC-ID 85	85	649.00
WC-ID 110	110	684.00
Rinse Ball Kit		172.00



TANKS

Clean Water Tanks



- Hand wash valve
- Easy filling
- Universal mounting
- UPS shippable



3-gallon tank and L brackets and valve - \$140.00
9-gallon tank - \$202.00

Refurbished IBC Totes

- 275-gallon
- Not approved for potable water
- \$275.00



IBC Dispensing Stand

- 52.25" x 45.25" x 27.25"
- \$517.00

ATV and Utility Vehicle Tanks

Shaped for ATV

Part Number	Gallons and Description	Dimensions	Price
216ATV	16-gallon Cottontail	ATV	\$ 345.00
25ATV	24.5-gallon Jackrabbit	ATV	363.00
EN55	55-gallon with sump	26 x 37 x 17.5	603.00
EN75	75-gallon with sump	27 x 41 x 23	645.00
EN75B	75-gallon with sump, black	27 x 41 x 23	692.00
EN100	100-gallon with sump	36 x 48 x 24	744.00
WC-UTV-50	50-gallon UTV low profile	31 x 38 x 12	475.00
WC-UTV-75	75-gallon UTV low profile	36 x 48 x 12	575.00



24.5-gallon Jackrabbit



50 and 75-gallon ultra low profile tanks with sump

PICKUP STYLE APPLICATOR TANKS

100-Gallon Pickup Style Applicator Tank

- Includes tank mounting bracket
- 42" H x 17" L x 70" W
- 48" wheel well cut out



WC-100-GC - \$573.00

WC-100-GC-Black - \$605.00

Floor length hose reel mount - \$382.00 per side

Floor length pump and engine mount - \$382.00 per side

400-Gallon Applicator Tank

- Includes tank mounting bracket
- 42" H x 52" L x 70" W
- 48" wheel well cut out



WC-400-10GC - \$1,098.00

WC-400-10GC-Black - \$1,155.00

Pump, engine, hose reel mount for tank - \$271 per side

200-Gallon Applicator Tank

- Includes tank mounting bracket
- 42" H x 27" L x 70" W
- 48" wheel well cut out

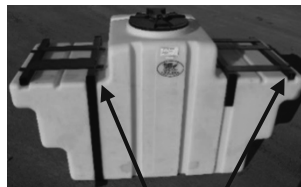

WC-200GC - \$790.00

WC200GC-Black - \$827.00

Pump, engine, and hose reel mount - \$271.00 per side

Floor length mounting tab - \$382.00 per side

Notes: • Pickup Style Applicator Units require 1/4" to 1/2" friction reducing material for equipment under tanks • Pickup style tanks do not fit the Ram toolbox bed • 400-gallon sprayer requires raised platform for pickups with 21.5" box sides

300-Gallon Applicator Tank

- Includes tank mounting bracket
- 38" H x 39" L x 70" W
- 48" wheel well cut out



WC-300-10GC - \$1,032.00

WC-300-10GC-Black - \$1,076.00

Pump, engine, and hose reel mount - \$271.00 per side

Floor length baseplate mounting tab - \$382.00 per side

Brackets for Pickup Style Tanks

Part Number	Price
WCE 200-HR-BRKT	\$271.00
WCE 200-PE-BRKT	271.00
WCE 200-HR-BRKT-FM	382.00
WCE 200-PE-BRKT-FM	382.00
WCE 300-HR-BRKT	271.00
WCE 300-PE-BRKT	271.00
WCE 300-HR-BRKT-FM	382.00
WCE 300-PE-BRKT-FM	382.00
WCE 400-HR-BRKT	271.00
WCE 400-PE-BRKT	271.00

TANK ACCESSORIES

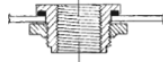

Tank Bulkhead Fittings

P/N	Description	Price
200-TF	2" bolted tank fitting	\$ 62.07
300-TF	3" bolted tank fitting	93.75
102BF05BD	3/4" total drain tank fitting	95.43
102BF100BD	1" total drain tank fitting	95.98
102BF125BD	1-1/4" total drain tank fitting	95.98
102BF220BD	2" total drain tank fitting	98.20
102BF300BD	3" total drain tank fitting	137.00

Polypropylene (Black) Bulkhead Fittings w/Gasket

P/N	Description	Price
43386	1/2" polypropylene bulkhead fitting	\$ 13.25
43388	3/4" polypropylene bulkhead fitting	13.25
43391	1" polypropylene bulkhead fitting	17.00
43393	1-1/4" polypropylene bulkhead fitting	17.00
43395	1-1/2" polypropylene bulkhead fitting	25.60
43397	2" polypropylene bulkhead fitting	25.60
HD 20-015	2" heavy duty/tank of 3000 gal	38.00
5037P	1-1/4" anti-vortex	34.64
5040P	1-1/2" anti-vortex	42.45
5041P	2" anti-vortex	41.93
BH20-010	3" polypropylene bulkhead fitting	65.10

EPDM Bulkhead Gasket

P/N	Description	Price
45814	1/2" and 3/4" bulkhead gasket	\$ 9.25
45815	1" bulkhead gasket	11.37
45816	1-1/4" bulkhead gasket	11.88
45817	1-1/2" and 2" bulkhead gasket	18.20

Sealing Collett Bulkhead Fitting

For top of tank to allow pass through of tubing

P/N	PVC Pipe Size	Price
M8437	1" ID	\$ 8.72
M4524	1-1/4" ID	16.50
M3317	1-1/2" ID	37.00
M3321	1-3/4" ID	43.00



Syphon Tubes

P/N	Description	Price
10511	2" short	\$ 5.75
10488	2" long	23.50
10489	3" long	34.80



Tank Webbing



P/N	Description	Price
46120	Tank webbing tie down nut	\$ 4.24*
46121	Tank webbing tie down bracket	6.30*
46716	Tank webbing 1-3/4" polyester	3.00/ft*
03728	Tank webbing 4" polyester	5.05/ft*
05748-95	4" anchor and bolt	19.50*
05785-95	2" anchor and bolt	11.70*

LIDS



10631	2" Ace lid with catch cup	\$ 6.48
10529	4" Ace center with vent	16.05
13696	5" Ace spin with vent	10.46
10525	8" Ace threaded with vent	28.70
3522221	8" Enduraplas 8" red air vent	27.90
5478R	10" Raven screw on	37.60
5479R	11" Raven ring for 10"	24.85
AG8169014	12" hinged with vent	69.14
10526	12" Ace threaded no vent	31.13
10527	12" Ace threaded with vent	37.68
10528	16" Ace threaded with vent	50.77
15082	16" Ace hinged with vent	74.80
303 63485	16" Norwesco	52.10

Lid Accessories

30012	Basket filter 8"	\$ 20.25
300126	Basket filter 12"	26.17
300119	Basket filter 16"	32.10
19026	Garden hose cap/gasket assembly Ace	1.85
3522120	Gasket 8"	9.80
3522140	Gasket 12"	14.37
3522160	Gasket 16"	18.55
12880	Gasket frame 16"	6.60
10873	Lanyard 12" short black (5" to 12" lids)	1.23
10534	Lanyard 16" long black (12" to 16" lids)	1.40
	Ring 16"	11.45



Stopping, starting, or rounding a cure – regardless of the amount of liquid in the tank, the floating "Surge Buster" eliminates surge by constantly deflecting the load in over a thousand different directions. Makes transporting large volumes of liquid safer and less stressful for operators. Flexible design fits any size or configuration of tank. NFPA compliant for use in fire trucks.

- One baffle per 30 gallons water
- Installs through tank top opening
- No interior attachments
- Works with or without existing baffle
- Safe for most chemicals and potable water



Size	Number Per Gallon	Price
15"	1 per 32-gallon	\$45.00 each
7"	1 per 15-gallon	\$42.00 each
4"	1 per 10-gallon	\$38.00 each

3-Point Hitch Sprayers

60-Gallon Category I

- 60-gallon tank
- 12-volt 4.5 gpm pump
- Boomless nozzle with right and left coverage
- Great unit for spot spraying noxious weeds and small pastures



Price as pictured - \$1,896.00*
WC3PT60

With 6-roller PTO pump - \$2,184.00*
WC3PT606

Option: 25' hose and Black Jewel handgun
Add \$228.00*

60-Gallon Category I

- 60-gallon tank
- 12' break away boom
- Manual boom control
- 12-volt 3 gpm pump
- Electric on and off from cab
- Great unit for large lawns, athletic fields, small pastures



Price as pictured - \$2,143.00*
WC3PT6012

With 6-roller PTO pump - \$2,431.00*
WC3PT60612

Option: 25' hose and Black Jewel handgun
Add \$228.00*



Boomless 3-Point Hitch Sprayer

WC3PT 200 **\$6,693.00***

- 200-gallon tank with agitation
 - Category I or II
 - Boominator nozzles right and left, 30' total swath
 - 6-roller PTO pump
 - Electric control right and left
 - Excellent unit for noxious weed control and pasture spraying
- Option: 50' of high-pressure hose and Black Jewel handgun - Add \$266.00*

200-Gallon 3-Point Hitch Sprayer

WC3PT242 **\$8,917.00***

- 200-gallon tank with agitation
 - Category I or II
 - 6-roller PTO pump
- 42' heavy duty boom with breakaway hinges
 - 3-section electric controls
 - One set of nozzles
- Suspension flotation kit on boom

Option: 50' of high-pressure hose and Black Jewel handgun - Add \$266.00*



Demco 300-Gallon 3-Point Hitch Sprayer

WC3PT345 **\$12,545.00***

- 300-gallon tank with agitation
 - Hydraulic driven pump
 - 45' manual fold boom
 - Shock kit on boom
- 3-section electric solenoid controls
 - One set of tips

Options: • 50' hose and Black Jewel handgun - Add \$266.00*
• Micro-Trak spray monitor available - inquire



PULL TYPE TRAILER SPRAYERS

Demco 300-Gallon Trailer Sprayer with 45' Boom
WCT340 **\$13,721.00***

Standard Features

- 45' truss boom
- Shock mount kit
- 11L x 15 8-ply tires
- PTO mounted 8-roller pump
- 3-way electric solenoid controls
- Includes one set of tips

Options

- Hydraulic wing leveling kit, installed ~ Add \$918.00*
- 50' of high-pressure hose and Black Jewel handgun ~ Add \$266.00*



Warne 300-Gallon Trailer Sprayer - Boomless
WCT300 **\$8,345.00***

Standard Features

- Spray bar and boomless nozzles with 42' of coverage, right and left boomless nozzles, center section boom
- 3-section swath with electric solenoid control
- 11L x 15 8-ply tires
- Excellent unit for noxious weeds, pasture spraying or small fields
- PTO mounted 8-roller pump

Option

- 50' of high-pressure hose and Black Jewel handgun - Add \$266.00*

Demco 500-Gallon Trailer Sprayer
WCT560 **\$ 33,846.00***

Standard Features

- Big wheel sprayer with 11.2 x 38 tires
- Adjustable axle
- Motorized ball valves
- Hydraulic driven pump
- Hydraulic wing lift
- 60' hydraulic boom
- Texas Remcor switch box
- Hydraulic fold

Options Available: Hose, handgun, GPS, MicroTrak sprayer monitors, 55-gallon flush kit

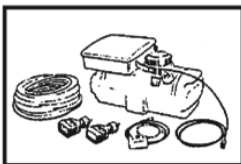

Foam Marking System ~ Option available for above units

A ready-to-use compact 12-volt foam marker designed for dependable, low-cost operation. The foamer comes complete to equip up to an 80' boom including R/L switch with 20' cable to foamer module. Unit features molded mounting lugs in bottom and strapping areas allowing easy installation. A 14-gallon foamer operates 2.5 to 3 hours on a fill at a cost of \$0.03 to \$0.04 per acre. Foam rates can be adjusted with replacement discharge orifices. Inquire on pricing.

NURSE TANK TRAILERS

Features: • 1010-gallon drainable tank • Heavy-duty 6" channel iron frame with fenders • Extended double plated tongue • Extra heavy-duty high speed cambered axles • 8000# slipper spring suspension per axle • Implement tires • Adjustable clevis • Powder coat paint • GX160 Honda engine with 2" direct coupled high-volume transfer pump • 22' discharge hose, valve, camlock connector • Plumbed to draw from both tank and fill nurse tank



Unit Price ~ WCNTT \$10,590.00*

Above unit with brakes, lights, 235 85 R16 tires and 2-5/16" ball hitch ~ WCNTTL \$12,910.00*

Options: • 1010-gallon tank and trailer only - \$8,400.00* • 1010-gallon tank and trailer only with electric brakes, lights 235 85 R16 tires - \$10,142.00* • Cone inductor tank (plumbed in system) - Add \$718.00* • Trailer with 4' platform - Add \$2,040.00* • GX160 Honda engine and 2" poly pump with wet seal - Add \$535.00* (in place of standard pump and engine)

GENERAL PURPOSE TRAILER SPRAYERS

- 200-gallon tank • 2-5/16" ball hitch • 15" tires • 3300 lb pay load
- Leaf springs and fenders • Lights • Jack



Model WC2005540 - \$5,815.00*

General purpose sprayer for trees and ornamentals, weed control, fire fighting, livestock spraying etc. Equipped with GX160 Honda engine, diaphragm pump 560 psi 10 gpm, 50' of high-pressure hose and Black Jewel handgun.

Options for above unit

- Manual hose reel with 150' of 1/2" high pressure hose, 1125-4-200 - Add \$690.00*
- 1125-4-200E electric hose reel - Add \$894.00*
- Additional 1/2" hose above 50' - Add \$1.75* per foot
- Hydraulic agitation - Add \$125.00*
- Root feeder - Add \$356.00*
- 50-amp electrical connector – Add \$85.00*

Model WC20055.5HCL - \$4,838.00*

General purpose sprayer for lawn care, turf, weed control, etc. Equipped with GX200 Honda engine, centrifugal spray pump, 50' of hose and Black Jewel handgun.

Options for above unit

- Manual hose reel with 150' of 1/2" 300 psi hose - Add \$690.00*
- Additional 1/2" hose above 50' - Add \$1.75* / ft
- Double boomless nozzles with electric solenoid control - Add \$890.00*
- 15' power lead with 30-amp breaker, 50-amp disconnect - Add \$148.00*
- Lawn care handgun - Deduct \$30.00
- Hydraulic agitation - Add \$125.00*
- 1125-4-200 electric hose reel - Add \$894.00*

75-GALLON "ROUGH COUNTRY" PULL TYPE SPRAYER

For use on pasture, turf, golf course, general purpose spraying, designed to be pulled behind UTV, ATV or garden tractor. Unit includes 75-gallon poly tank, 25' hose and Black Jewel handgun, solid axle, sealed bearings, slipper suspension springs and 22x10x8 tires, 3/16" formed steel frame. Unit designed for rough terrain.

Unit as listed above

With: 12-volt 4.9 gpm pump, double Boominator nozzles with left/right solenoid control and switch box **WCT75RC12 \$3,089.00***

With: GX160 Honda engine and self-priming centrifugal pump, double Boominator nozzles left/right solenoid control and switch box **WCT75RCC \$4,086.00***

With: GX120 Honda engine and 4-roller pump, double Boominator nozzles, left/right solenoid control and switch box **WCT75RC4 \$3,750.00***

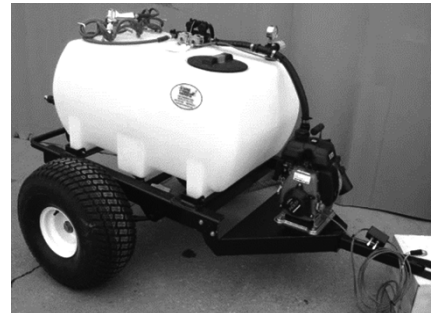

Options For Above

- 12' rear folding boom with 2-section plumbing, double solenoid control and switch box (in place of boomless nozzles) - Add \$290.00
- Above tank hose reel rack - Add \$185.00 • Spare tire and wheel - Add \$169.00 • Hose reel with 100' of 3/8" hose - Add \$465.00

40-GALLON "BULLDOG" TRAILER SPRAYER

WCT40BD \$1,420.00*

Unit is built for uneven and less than perfect terrain

Standard Features

- 40-gallon poly tank • 12- volt 3 gpm pump • Toggle switch control box (for pump on/off) • Single Econo Boominator nozzle 12' - 16' coverage • Large 20 x 10 x 8 flotation tires • Low speed, sealed axle bearings • Pin hitch • 15' hose and premium handgun
- Option:** Spare tire and wheel - Add \$169.00*



25-GALLON ESTATE SPRAYER

500 ES025-80 \$557.00*

This pull type sprayer for turf spraying features a fused 12-volt diaphragm pump and bypass pressure control. 80" boom coverage is provided by two flood-jet nozzles. 15" poly trigger-jet hand wand with adjustable nozzle is standard.

Same as above with 120" boom coverage and 3 gpm pump **500 ES025-120 - \$650.00***



300 AND 500-GALLON TRAILER SPRAYERS FOR TURF AND ORNAMENTAL INDUSTRY

Model WCTR8055 - \$12,400.00* ~ **Tree sprayer** equipped with 300-gallon poly tank, baffle, and double dual hydraulic agitation; GX270 Honda engine; diaphragm pump 15.5 gpm, 560 psi; manual hose reel with 300' of 1/2" 800 psi hose; 5000 lb tandem axles with electric brakes on back axle, lights, 2-5/16" ball hitch, jack stand, rear loading stand and safety rail.

Model WCTR9051 - \$9,421.00* ~ **Lawn sprayer** equipped as above with GX200 Honda engine and centrifugal pump with pressures up to 110 psi and lawn care handgun.

Options	Add
• 500-gallon elliptical tank	\$735.00*
• Surge Buster baffle system for 500-gallon tank	749.00*
• Electric start for Honda GX270 engine	325.00*
• Honda GX270 engine with centrifugal pump up to 140 psi	984.00*
• Electric hose reel	550.00*
• Reel rack as pictured	195.00*
• Roller kit for hose reel	241.00*
• Root feeder	356.00*
• Oil drainzit	29.80*
• Clean water tank	140.00*
• Bottom fill kit	220.00*
• 25' power lead with 30-amp breaker and 50-amp disconnect	148.00*



Please inquire about configurations and pricing for units requiring a GX390 and GX630 Honda engine for taller tree spraying.

HIGH-PRESSURE GENERAL-PURPOSE SPRAYER

This sprayer is designed to serve as a high-pressure sprayer performing from 30 to 560 psi at 15.5 gpm for weed spraying, tree spraying, fire fighting, washing, etc

Basic Unit Specs

Model WCGPHP150

- 150-gallon poly tank
- GX270 Honda engine
- Diaphragm pump producing 560 psi, 15.5 gpm
- 100' of 1/2" 800 psi high pressure hose
- 43H brass handgun with long range tip
- Jet agitation
- Skid mounted for truck or trailer

Assembled and Operational - \$5,660.00*

High Volume Unit Specs Model WCHPHV150

- 150-gallon poly tank
- GX390 Honda engine
- Diaphragm pump producing 560 psi, 19.5 gpm
- 100' of 5/8" high pressure hose
- Braglia long distance handgun
- Hydraulic agitation
- Skid mounted for truck or trailer

Assembled and Operational - \$6,490.00*



**Custom
Made
Units
Available**

Options to customize for your use	Add
• 200-gallon poly tank	\$210.00*
• 300-gallon poly tank	397.00*
• 300-gallon elliptical tank	687.00*
• 500-gallon poly tank	738.00*
• 500-gallon elliptical tank	1,025.00*
• Electric start option, B&S or Honda	325.00*
• Braglia long distance handgun	207.00*
• Additional 800 psi 1/2" spray hose (neon)	4.67* / ft
• Additional 800 psi 5/8" spray hose	4.65* / ft
• Deep root feeder attachment	356.00*
• High pressure manual reel	369.00*
• High pressure electric reel	940.00*
• High pressure manual reel, 3/4"	599.00*
• High pressure electric reel, 3/4"	1,124.00*
• High pressure quick coupler disconnects	46.80*
• 4-way hose roller system	241.00*
• Above pump and engine hose reel mount	175.00*
• Camlock bottom fill kit	220.00*
• 3-gallon clean water tank	140.00*
• Oil drainzit for Honda engines	29.80*
• 25' power lead with 30-amp breaker	95.70*
• 25' power lead with 30-amp breaker & 50-amp disconnect	148.00*
• Forklift tubes on skid	392.00*
Please inquire about other options available: Fiberglass tanks, trailer mounted unit, pump and engine units up to 32 gpm at 70 psi	

WARNE BALE BED READY SPRAYERS



200-GALLON BALE BED SPRAYER

Designed for bale bed trucks with a variety of pump options.
Units to be picked up by a bale bed unit or fork pockets for skid steer / forklift.



FIRE UNIT

WCBFF

\$7,899.00

Standard Features: • 200-gallon poly tank • GX160 Honda engine, recoil start • Two stage fire pump (65 gpm and 48 psi) (20 gpm and 120 psi) • 100' of 3/4" booster hose • Manual hose reel • Poly adjustable pattern fire nozzle • Unit plumbed with drafting capability

Options: • Surge Buster baffle system - Add \$299.00 • Electric hose reel - Add \$590.00 • Alloy adjustable pattern nozzle in place of plastic nozzle - Add \$85.00 • Viper pistol grip fire nozzle in place of plastic nozzle - Add \$502.00 • Guzzler primer pump - Add \$160.00 • 25' of 1-1/2" drafting hose with cast iron foot valve - Add \$215.00 • Site gauge - Add \$98.00 • 150-gallon tank in place of 200-gallon tank - Deduct \$176.00 • Honda GX270 electric start with high volume two stage pump (120 gpm and 36 psi), (20 gpm and 144 psi) in place of GX160 engine and pump - Add \$890.00 • 100' of 1" ultra lite wildland fire hose on manual reel in place of 3/4" reel and 3/4" booster - Add \$390.00

UNITS FOR CATTLE SPRAYING, WEED SPRAYING, TREE SPRAYING, FIRE FIGHTING

WCBBD

\$7,472.00

Standard Features: • 200-gallon poly tank • GX160 Honda engine • Diaphragm pump (560 psi and 10 gpm) • 100' of 1/2" spray hose on manual hose reel • Pistol grip variable pattern handgun

Options: • 100' of 1/2" Hercules fire hose - Add \$1,055.00 • Electric hose reel in place of manual hose reel - Add \$550.00 • Four-way hose roller guide - Add \$241.00 • Agitation - Add \$145.00 • Electric start engine - Add \$325.00 • 150-gallon tank in place of 200-gallon tank - Deduct \$176.00

WCBBR

\$6,972.00

Standard Features

• 200-gallon poly tank • GX160 Honda engine, 8-roller pump (300 psi max pressure) • 100' of 1/2" 600 psi spray hose • Manual hose reel • Pistol grip variable pattern handgun

Options: • Additional spray hose - Add \$1.75 per foot • Electric hose reel in place of manual reel - Add \$550.00 • Four-way hose roller guide - Add \$241.00 • Agitation - Add \$145.00 • 150-gallon tank - Deduct \$176.00

GENERAL PURPOSE COMMERCIAL SPRAYING UNIT WITH 200, 300 OR 400-GALLON PICKUP STYLE TANK

Designed to maximize pickup bed space. Pump and engine unit and reel mount on tank.

WC 200-10GC

\$5,900.00*

- 200-gallon pickup tank
- GX160 Honda engine
- Diaphragm pump producing 10.5 gpm 560 psi
- Manual hose reel
- 200' of 1/2" hose
- Black Jewel handgun
- Hydraulic agitation
- 42" H x 27" L x 70" W

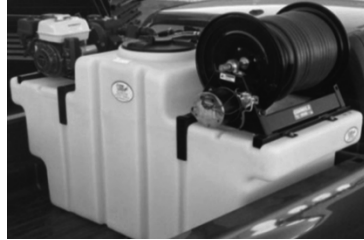

Options

- 12-volt electric reel
Add \$550.00*
- 4-way hose roller guide assembly
Add \$241.00*
- Oil drainzit for Honda engine
Add \$29.80*
- Braglia long range handgun
Add \$207.00*
- Deep root feeder attachment
Add \$356.00*
- Additional 1/2" high pressure hose, 600 psi
Add \$1.75* per foot
- Electric start for Honda engine
Add \$325.00*
- 25' power lead with 30-amp breaker
Add \$95.70*
- 25' power lead with 30-amp breaker and 50-amp disconnect
Add \$148.00*
- 400-gallon base platform for elevating tank
Add \$340.00*
- Pump, engine, and hose reel mount with floor length mounting tabs
Add \$90.00* per side
- Fits 200 or 300-gallon units only

WC 300/400-10GC

\$6,295.00*

- 300 or 400-gallon pickup tank
- GX160 Honda engine
- Diaphragm pump producing 10.5 gpm 560 psi
- 200' of 1/2" hose
- Manual hose reel
- Black Jewel handgun
- Hydraulic agitation
- General purpose spraying

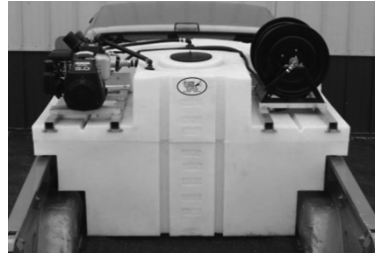

WC 300/400-15GX

\$6,828.00*

- 300 or 400-gallon pickup tank
 - GX160 Honda engine
- Diaphragm pump producing 22 gpm 285 psi
 - Manual hose reel
 - 200' of 1/2" hose
 - Black Jewel handgun
 - Hydraulic agitation
- Lawn care, industrial weed and general-purpose spraying

WC300/400-15 GX8

\$7,303.00*

- 300 or 400-gallon pickup tank
- GX270 Honda electric start engine
- Diaphragm pump producing 15.5 gpm 560 psi
 - 200' of 1/2" 800 psi hose
 - Manual hose reel
 - Black Jewel handgun
 - Hydraulic agitation
- Tree spraying, pest control and high-pressure spraying

Notes

- Tank combos available – inquire; for example 100/200, 200/300, 300/300
- 400-gallon requires raised platform for pickups with 21.5" box sides
- Sprayer does not fit the Dodge Ram toolbox bed
- Tank does not completely evacuate due to flat bottom design

SPRAYERS

ECONO SKID MOUNTED SPRAYER

WCECONO \$4,367.00*

Standard Features:

- 200-gallon general use sprayer • Poly tank
- GX160 Honda engine • 8-roller pump, 300 psi max
- Manual reel with 100' of 1/2" high pressure hose and Black Jewel handgun
- Unit can be used for weed spraying, fire fighting, cattle spraying, etc

- Options:**
- Hydraulic agitation - Add \$145.00*
 - Additional 50' of 1/2" hose - Add \$90.00*

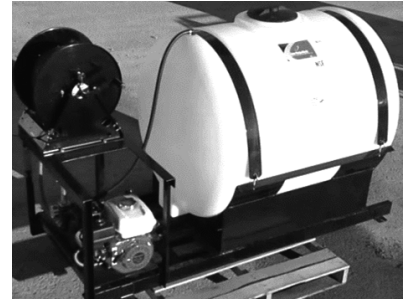

RANGE AND PASTURE SPRAYER

WCR&P200 \$6,650.00*

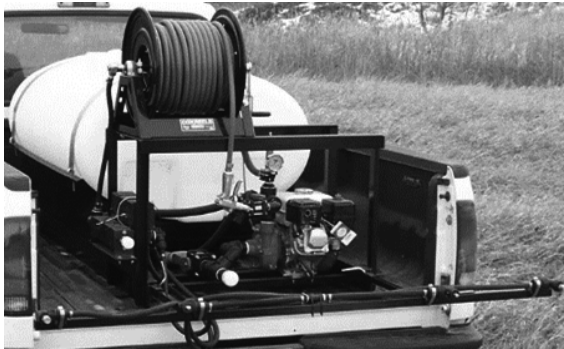

Standard Features:

- 200-gallon elliptical low profile tank
 - Skid mounted
- GX200 Honda engine and centrifugal pump
- Spray bar and boomless nozzles with 42' coverage, 19 gpa @ 5 mph, 30 psi, right and left boomless nozzles, center section boom
 - Electric cab controls with solenoid valves
- Manual hose reel with 100' of 1/2" hose mounted above pump and engine unit
 - Black Jewel handgun

Options:

- 300-gallon elliptical tank - Add \$375.00*
- 400-gallon elliptical tank - Add \$552.00*
- 500-gallon elliptical tank - Add \$815.00*
- Electric ball valves - Add \$675.00* (in place of solenoid valves)
- Electric hose reel - Add \$550.00*
- Spray monitor and controls - Inquire
- Mounting and wiring at our facility - Add \$375.00*
- Oil drainzit - Add \$29.80*
- Additional hose - Add \$1.75* per foot

GENERAL PURPOSE WEED SPRAYER WITH BOOMLESS NOZZLES

WCGPBL \$4,485.00*

- Designed for pickup or trailer mount • Works well for noxious weeds and pasture spraying

Standard Features:

- 200-gallon skid mount
 - GX160 Honda engine
 - 8-roller pump
- Boomless nozzles with 36' swath, 18' per side
 - Right/left electric controls from cab
 - High/low pressure control
- High pressure for handgun spraying, fire fighting
 - Low pressure for boomless nozzles
- 50' of hose and trigger operated handgun

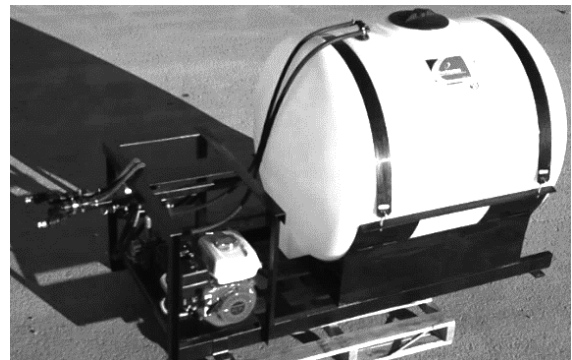

Options:

- Manual hose reel - Add \$375.00*
 - Jet agitation - Add \$175.00*
- 100' of 1/2" high pressure hose with banded ends - Add \$239.00*

COMMERCIAL WEED SPRAY UNIT

WCCOM150 \$4,872.00*

This sprayer is designed for lower pressure, higher volume applications. Pressures from 20 to 110 psi with high volume of spray solution. Use for weed spraying, boomless nozzles, lawn care.

Standard Features

- 150-gallon poly tank
- Skid mounted for truck or trailer
- GX200 Honda engine
- High volume centrifugal pump producing 113 psi
- Hydraulic agitation
- Lawn applicator handgun
- 100' of 1/2" vinyl coated 300 psi hose



Options to customize for your use

- | | |
|--|---|
| <ul style="list-style-type: none"> • 200-gallon poly tank - Add \$196.00* • 300-gallon poly tank - Add \$390.00* • 200-gallon elliptical tank - Add \$400.00* • 300-gallon elliptical tank - Add \$630.00* • 500-gallon elliptical tank - Add \$940.00* • Electric start - Add \$325.00* • Manual hose reel - Add \$368.00* • Electric hose reel - Add \$904.00* | <ul style="list-style-type: none"> • Forklift tubes on skid - Add \$392.00* • Above pump and engine hose reel mount - Add \$175.00* • Additional 600 psi hose - Add \$1.75*/ft • Bottom fill kit - Add \$210.00* • 3-gallon clean water tank - Add \$140.00* • 4-way hose roller system - Add \$241.00* • Oil drainzit for Honda engine - Add \$29.80* • 25' power lead with 30-amp breaker - Add \$95.70* • 25' power lead with 30-amp breaker, 50-amp disconnect - Add \$148.00* |
|--|---|

150, 200 AND 300-GALLON SKID MOUNTED HIGH PRESSURE SPRAYERS

For weed spraying, cattle spraying, fire fighting, tree spraying, washing equipment, etc

Standard Features:

- Polyethylene tank
- GX160 Honda engine
- Diaphragm pump
- 560 psi 10 gpm
- 50' of high pressure hose
- Trigger operated variable pattern handgun
- Heavy duty skid



150-Gallon with GX160 Honda Engine
WCHP150 \$4,504.00*

200-Gallon with GX160 Honda Engine
WCHP200 \$4,754.00*

300-Gallon with GX160 Honda Engine
WCHP300 \$5,209.00*

Options: • Additional hose - Add \$1.75* per foot • Hydraulic agitation - Add \$145.00* • Manual reel with 100' of 1/2" hose - Add \$521.00* • Manual reel with 100' of 1/2" fire resistant hose - Add \$1,066.00*

55-GALLON GENERAL PURPOSE SPRAYER

Standard Features

- Wrap around frame
- 25' hose
- Black Jewel handgun
- 125 psi

With the following pump and engine unit:

4.5 gpm 12-volt pump	45 psi	WCGP55WP12	\$1,390.00*
GX160 Honda engine with centrifugal pump	64 psi	WCGP55WPC	2,121.00*
GX120 Honda engine with 4-roller pump	125 psi	WCGP55WP4	1,979.00*
GX120 Honda engine with 7 gpm diaphragm pump	350 psi	WCGP55WP7	3,575.00*

- Option:** • Double boomless nozzles with single electric valve - Add \$741.00*
- Hose reel and 100' of 3/8" hose - Add \$485.00*
 - Additional 3/8" hose above 25' - Add \$1.25* / ft

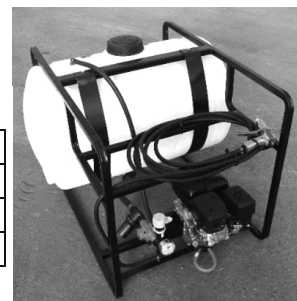

25-GALLON AQUATIC WEED SPRAY UNIT

WCAQ25

\$949.00*

Designed for aquatic weed control applications

- 25-gallon tank
- 10' folding boom with drop nozzles
- 15' of hose with spray wand



LIQUID ICE MELT APPLICATORS FOR DE-ICING AND ANTI-ICING

PICKUP MOUNTED UNIT

WCPUIM

\$5,240.00*

Standard Features:

- Skid mounted 300-gallon PCO tank with baffles
- GX160 Honda engine with 2" pump
- Single boom behind vehicle
- Electric on/off from cab
- Pump unit can be used to fill tank
- All components are corrosion resistant for magnesium chloride



Options:

- 150-gallon tank, no baffle - Deduct \$227.00
- 200-gallon tank, no baffle - Deduct \$110.00
- 500-gallon elliptical tank, no baffle - Add \$801.00*
- Bottom fill kit with incoming strainer - Add \$290.00*
- Oil drainzit - Add \$29.80*
- Hose reel with 100' hose and handgun - Add \$645.00*
- John Blue wet seal pump in place of standard pump - Add \$639.00
- 8' boomless nozzle with electric control, right - Add \$685.00*
- 8' boomless nozzle with electric control, left - Add \$685.00*
- Hose and handgun kit - Add \$246.00*
- Automatic flow control - Inquire
- 12-volt on/off, 3-section control box - Add \$567.00*
- Surge Buster baffle kit for 500-gallon tank - Add \$749.00*

Larger and custom built units available - Inquire

75-GALLON UTV UNIT

WC75IM

\$4,115.00*

Standard Features for Liquid Ice Melt

- 75-gallon tank • GX160 Honda engine with poly SP centrifugal pump • 10' spring loaded boom with center section for sidewalk and fold-out side wings for parking lots • On/off from cab • Manual hose reel with 75' of hose and handgun • Plumbed for regular nozzles or drill nozzles, 10" spacing



Options:

- Drill nozzles
- 12-volt Dura pump in place of gas driven pump - Deduct \$290.00



75-GALLON PEST CONTROL / GENERAL PURPOSE SPRAYER

WC75ULPPC \$4,325.00*

- 75-gallon low profile tank with internal sump
- Hydraulic agitation
- Honda GX120 engine with UDOR diaphragm pump up to 275 psi
- 250' of light weight Red Slider hose with 1000 psi working pressure, non-kink and applicator friendly
- Black Jewel handgun
- 36" x 48" x 12" high (37" to top of hose reel)

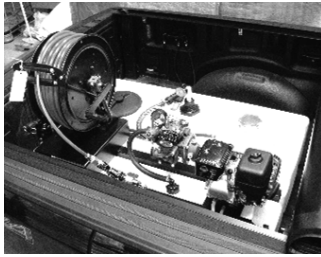

Unit is a versatile pest control / termite treatment unit.
Also an excellent weed or small tree and shrub sprayer.

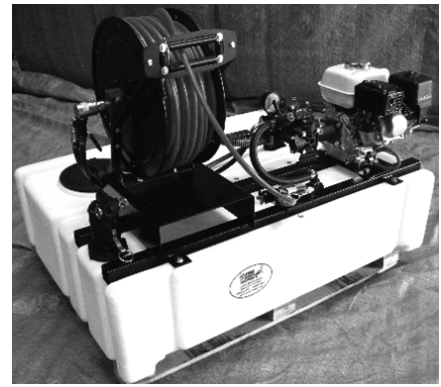

75-GALLON PEST CONTROL SPRAYER

WCPCS75 \$3,670.00*

- Low profile tank
- GX120 Honda engine
- Six-roller pump
- Manual hose reel with 200' of 3/8" high-pressure hose
- Pistol grip variable pattern handgun
- Designed for the pest control industry
- Tank gallonage indicator and sump for complete drainage
- Hydraulic jet agitation
- 46" long x 41" wide x 27" to top of tank or 39.5" to top of hose reel

Options

- 12-volt electric hose reel in place of manual reel - Add \$550.00*
- Oil drainzit - Add \$29.80*
- Additional 3/8" high pressure hose - Add \$1.35*per foot
- Quick coupler disconnect at hose and handgun - Add \$46.80*
- Diaphragm pump (350 psi, 7 gpm) coupled to GX120 Honda engine in place of standard pump/engine - Add \$910.00*



GForce MIST SPRAYERS AND MIST BLOWERS

- Spray your roughest tough spots such as ravines, ditches, fence lines, trees, and brush areas
- Spray livestock and around hog and poultry building sites
- Spray grasshoppers, mosquitoes, and other biting insects



Tyrant Mist Sprayer - \$3,360.00*

- Skid Mounted for UTV or Pickup
- 25-gallon poly tank
- Kohler Pro 207cc engine driven 9" fan
- 12-volt electric pump
- Two nozzles
- 210-degree manual volute rotation
- Spray coverage 65' horizontal, 30' vertical
- Battery not included

3-Point Hitch GF3P100HP - \$5,075.00*

- 100-gallon tank
- Agitation in tank
- 12" PTO driven fan
- Electric on/off
- Roller pump
- 210-degree hydraulic volute rotation
- Spray coverage 160' horizontal, 85' vertical
- Air speed to 160 mph



6-GALLON FLY FOGGER AND SPRAYER

500 FS006 \$935.00

12-volt system that lets you fog or straight stream your choice of fly sprays. Pump delivers a maximum 225 psi. Adjustable relief valve lets operator decide the pressure from 0 to 225 psi. Includes a 6-gallon tank, 18" spray gun, 30' of hose and a 15' wiring harness with battery clips that hook to a vehicle battery or deep cycle marine battery. Use for livestock on pasture, in feed lots, confinement, dairy barns, manure pits, bunk lines or anywhere flies are a problem. Battery not included.

FIRE FIGHTING UNITS

PICKUP STYLE FIRE FIGHTING UNITS

- Standard features:
- Surge Buster baffle system
 - GX160 Honda manual start engine
 - Direct coupled two stage pressure type centrifugal pump (65 gpm 48 psi and 20 gpm 120 psi)
 - Manual hose reel
 - Twist grip variable pattern handgun

400-Gallon Unit

WCPU400FF \$6,248.00*

- 400-gallon black polyethylene pick-up tank
- 100' of 1" ultra-lite forestry hose
- Designed to utilize only 52" of pickup bed



300-Gallon Unit

WCPU300FF \$6,114.00*

- 300-gallon black polyethylene pick-up tank
- 100' of 1" ultra-lite forestry hose
- Designed to utilize only 41" of pickup bed



200-Gallon Unit

WCPU200FF \$5,975.00*

- 200-gallon black polyethylene pick-up tank
- 100' of 3/4" booster hose
- Designed to utilize only 28" of pickup bed



- Options:**
- Twist grip adjustable cast alloy nozzle (in place of plastic nozzle) - Add \$85.00*
 - Sight gauge - Add \$98.00*
 - 25' of 1-1/2" drafting hose and foot valve - Add \$215.00
 - Electric reel - Add \$590.00*
 - 400-gallon base platform for elevating tank - Add \$340.00*
 - Roller assembly for electric reel - Add \$241.00*
 - Guzzler Primer pump - Add \$200.00*
 - Scotty 4171 Around-the-Pump foam eductor - Call for pricing
 - Foam applicator kits - Call for pricing
- Note:** 400-gallon sprayers require raised platform for pickups with 21.5" box sides • Sprayer does not fit the Dodge Ram toolbox bed

75-GALLON UTV MOUNTED FIRE FIGHTER

WCUTVFF \$4,450.00*

- 75-gallon black polyethylene tank with sump
- GX160 Honda engine with Davey 1.5" fire pump, dual stage 20 gpm 120 psi and 65 gpm 48 psi
- 1.5" drafting capacity
- 1.5" to 1" outlet
- Manual hose reel with 75' of 3/4" booster hose with trigger operated variable pattern nozzle
- Measures 46" L x 39" W x 23" to top (47" to hose reel top)



Rear mount



Side mount

- Options:**
- Surge Buster baffle system - Add \$95.00*
 - Hose reel roller assembly - Add \$165.00*
 - Guzzler Primer pump - Add \$200.00*

FIRST BLAST FIRE FIGHTER WC25FBFF \$456.00*

Fire protection you can carry with you for initial assault on small equipment and grass fires - protecting your equipment, investment, crop, or pasture.

- General purpose mounting for combines, balers, trucks, ATV and UTV
- Portable for vehicle to vehicle
- 12-volt 4 gpm pump
- 35' of hose and handgun
- 25-gallon capacity for up to 15 minutes of fire fighting
- Add *X-tra Wet* to the water to increase fire fighting efficiency
- X-tra Wet* 2 x 2.5-gallon per case \$41.88 per 2.5-gallon container



BAFFLED POLY FIRE FIGHTER WC300BFF \$6,990.00*

- 300-gallon black baffled poly tank
- GX270 Honda electric start engine
- Direct coupled two stage pressure type centrifugal pump (120 gpm 36 psi and 20 gpm 144 psi)
- 100' of 1" ultra-lite forestry hose
- 1" manual crank hose reel
- Adjustable pattern nozzle
- Steel skid mounted
- Built on an 8'5" skid

- Options:**
- Electric reel - Add \$590.00
 - Roller guide assembly for electric reel - Add \$241.00
 - Clear sight gauge - Add \$98.00
 - Twist grip adjustable cast alloy nozzle (in place of plastic nozzle) - Add \$85.00
 - Guzzler Primer pump - Add \$209.00



FIRE FIGHTING PUMP UNITS AND ACCESSORIES

DAVEY AK308 TWO STAGE PUMP - \$2,841.00*

- GX270 Honda electric start engine
- 120 gpm and 36 psi
- 20 gpm and 144 psi
- 3-way discharge manifold (one 1-1/2", two 1" ports)
- Economical, yet high efficiency pump
- KG01108 Seal Kit - \$220.50



DAVEY AK304 TWO STAGE PUMP - \$1,992.00*

- GX160 Honda recoil start engine
- 65 gpm and 48 psi
- 20 gpm and 120 psi
- 3-way discharge manifold (one 1-1/2", two 1" ports)
- KG01107 Seal Kit - \$220.50



KOSHIN PUMPS

High Pressure Centrifugal Pump

- 1-1/2" inlet and outlet
 - Honda GX50 engine
 - 30 gpm and pressures to 64 psi
 - Maximum suction lift 26'
 - Excellent sprayer or transfer pump
 - Not rated for fertilizer
- SEH-40H 1-1/2" NPT **\$695.00**



- Same specs as above engine except 1" inlet and outlet
 - 10 gpm and pressures to 64 psi
 - Very nice pump and engine for small sprayer
 - Not rated for fertilizer
- SEH-40H 1" **\$735.00**

**LARGER CAPACITY FIRE PUMPS AVAILABLE -
CALL FOR PRICING**

FIRE HOSE

Part No	Description	PSI	Color	Price
10035650	3/4" Booster hose	300	Red	\$3.10 / ft
10035660	1" Booster hose	300	Red	4.70 / ft
10041152	1/2" Hercules high pressure fire resistant	500	Yellow	10.55 / ft
10041156	3/4" Hercules high pressure fire resistant	500	Yellow	13.20 / ft
10041158	1" Hercules high pressure fire resistant	500	Yellow	17.00 / ft
AR100RXXX	1" Ultra lite hose with 1" NPSH male and female ends	300	Red Fire Hose	454.00 / 100 ft

FULL LINE OF WILDLAND HOSE AVAILABLE

FIRE NOZZLES, VALVES, AND THREAD ADAPTERS

Part No	Description	Price
Viper	1" stirrup handle pistol grip ball valve with 10-23 gpm nozzle, 1" NH female thread	\$542.00
Red Lexan Fire	1" NPS adjustable fog to straight stream, 100 psi	39.20
NZ009	10-24 gpm aluminum adjustable nozzle with bumper, 1" female NPSH thread	130.50
NZ016	10-24 gpm aluminum adjustable nozzle with bumper, 3/4" female garden hose thread	136.00
NZ027	Mini adjustable fan/stream stirrup nozzle, 3/4" female garden hose thread	141.00

NH or NST – Course Fire Hose Thread

NPSH – Fine Fire Hose Thread, Straight

NPT – National Pipe Thread, Tapered

INQUIRE ABOUT GALLON SELECTABLE NOZZLES

"GUZZLER" HAND PRIMER PUMP

12 gpm, 10"x5"x4"

P-360 \$160.00

Replacement G4/5 Diaphragm \$28.90



SCOTTY 4171 AROUND-THE-PUMP FOAM EDUCTOR

Educts foam concentrate into hose lines through a pump's suction and discharge sides Call for pricing.

4171KIT FOAM APPLICATOR KIT

Includes one 1-1/2" cast aluminum connecting tee and one 2" cast aluminum connecting tee in addition to pressure and pickup hoses. Call for pricing.



GENERAL PURPOSE UTILITY VEHICLE SPRAYERS

DESIGNED TO FIT IN THE BACK OF 4x4 AND 6x6 ALL TERRAIN VEHICLES

Refer to manufacturer's specifications for load carrying capacity

100-Gallon Gas UTV Sprayer

WCUTV100C

\$3,743.00*

• 100-gallon low profile tank with sump for complete draining • 8" fill well • Self-priming centrifugal pump with Honda engine • Double boomless nozzles with 30' swath (15' right, 15' left) • Electric right/left control from cab • 15' hose and pistol grip handgun • 48" W x 48" L x 26" H to top of tank • Unit fits in most large UTVs, low center of gravity and compact

Options:

- Manual reel and 100' of pesticide resistant 3/8" hose - Add \$465.00*
- Roller guide for above hose reel - Add \$153.00*
- Manual hose reel and 50' of pesticide resistant 3/8" hose - Add \$252.00*
- Manual hose reel with roller guide and 200' of slippery hose - Add \$855.00*
- GX120 Honda engine and 6-roller pump unit - Add \$470.00*
- Hydraulic agitation - Add \$95.00*
- Surge Buster baffle system - Add \$95.00*
- 18' foldable boom in place of boomless nozzles - Add \$157.00*



100-Gallon 12-Volt UTV Sprayer

WCUTV10012

\$2,986.00*

• 100-gallon low profile tank • 8" fill well • Double boomless nozzles with 30' swath (15' right, 15' left) • 12-volt 5.3 gpm pump • Electric on/off and right/left control from cab • 15' hose and pistol grip handgun • 48" W x 48" L x 26" to top of tank

Options:

- Manual hose reel with 100' of 3/8" hose - Add \$465.00*
- Roller guide for above hose reel - Add \$153.00*
- Manual hose reel with 50' of 3/8" pesticide resistant hose - Add \$252.00*
- Manual hose reel with roller guide and 200' of slippery hose - Add \$855.00*
- Hydraulic agitation - Add \$95.00*
- Surge Buster baffle system - Add \$95.00*



75-Gallon Gas UTV Sprayer

WCUTV75C

\$3,354.00*

• 75-gallon low profile tank with complete draining sump • 8" fill well • Self-priming centrifugal pump with Honda engine • Double boomless nozzles with 30' swath (15' right and 15' left) • Electric control right and left from cab • 15' hose and pistol grip handgun • 42" L x 40" W x 34" to top of hose reel, 27" to top of tank • Unit fits in most large UTVs and has low center gravity and compact design

Options

- Manual hose reel and 100' of pesticide resistant 3/8" hose - Add \$465.00*
- Roller guide for above hose reel - Add \$153.00*
- Manual hose reel and 50' of 3/8" pesticide resistant hose - Add \$252.00*
- Manual hose reel with roller guide and 200' of slippery hose - Add \$855.00*
- GX120 Honda engine and 6-roller pump unit - Add \$470.00*
- Hydraulic agitation - Add \$95.00*
- Surge Buster baffle system - Add \$95.00*
- 18' foldable boom in place of boomless nozzles - Add \$157.00*

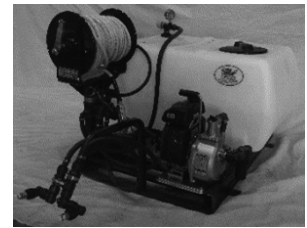

75-Gallon 12-Volt UTV Sprayer

WCUTV7512

\$2,708.00*

• 75-gallon low profile tank with complete draining sump • 12-volt 5.3 gpm 90 psi pump • Double boomless nozzles with 30' swath (15' right, 15' left) • Electric on/off and right/left from cab • 15' hose and pistol grip handgun • 42" L x 40" W x 34" to top of hose reel, 27" to top of tank • Unit fits in most large UTVs and has low center gravity and compact design

Options

- Manual hose reel with 100' of 3/8" pesticide resistant hose - Add \$465.00*
- Roller guide for above hose reel - Add \$153.00*
- Manual hose reel with 50' of 3/8" pesticide resistant hose - Add \$252.00*
- Manual hose reel with roller guide and 200' of slippery hose - Add \$855.00*
- 18' foldable boom in place of boomless nozzles - Add \$157.00
- Hydraulic agitation - Add \$95.00*
- Surge Buster baffle system - Add \$95.00*

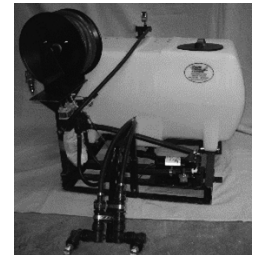

55-Gallon 12-Volt UTV Sprayer

WCUTV55

\$2,411.00*

• Tank has total drain sump • Fits in cargo boxes of most utility vehicles • 12-volt 5.3 gpm 90 psi pump • Double boomless nozzles • Electronic on/off right/left • 15' hose and piston grip handgun • Skid base dimensions 39" W x 38" L x 22" H

Options

- Manual hose reel with 100' of 3/8" pesticide resistant hose - Add \$465.00*
- Roller guide for above hose reel - Add \$153.00*
- Manual hose reel and 50' of 3/8" pesticide resistant hose - Add \$252.00*
- Hydraulic agitation - Add \$95.00*
- Surge Buster baffle system - Add \$95.00*



60-Gallon Utility Vehicle Sprayer

WCUTV60

\$1,299.00*

• Economy model for the occasional user • 60-gallon poly tank • 12-volt 4.5 gpm pump • Double econo Boominator tips (15' right, 15' Left) • Electronic on/off from cab • 15' hose and hand wand • Manual valve control right/left • 30" H x 35" W x 32" at base • Fits in cargo box of most utility vehicles



ULTRA LOW PROFILE UTV SPRAYERS

Ultra Low Profile 50-Gallon UTV Sprayer WC50ULP12 \$2,425.00*

- Internal sump • 12-volt 5.3 gpm 90 psi max • Double boomless nozzles with 30' (15' right, 15' left) spray pattern controlled from cab with 12-volt solenoid • 15' of hose and pistol grip handgun • Tie down rings • Fits in smaller UTV and has a low center of gravity
- Tank measures 31" L x 38" W x 12" H

- Options:**
- Manual hose reel with 100' of 3/8" hose - Add \$465.00*
 - Roller guide for above hose reel - Add \$153.00*
 - Manual hose reel with 50' of 3/8" hose - Add \$252.00*
 - Hydraulic agitation - Add \$95.00*
 - Legs for bolting unit to floor of UTV - Add \$45.00*

Note: To completely evacuate tank, use wet/dry vac



Ultra Low Profile 75-Gallon UTV Sprayer WC75ULP12 \$2,565.00*

- Internal sump • 12-volt 5.3 gpm pump, 90 psi • Double boomless nozzles with 30' (15' right, 15' left) spray pattern controlled with 12-volt solenoid valves from cab • 15' of hose and pistol grip handgun • Fits in most UTVs and has a low center gravity • Tie down rings • Tank measures 36" L x 48" W x 12" H

- Options:**
- Manual hose reel with 100' of 3/8" hose - Add \$465.00*
 - Roller guide for above hose reel - Add \$153.00*
 - Manual hose reel with 50' of 3/8" hose - Add \$252.00*
 - Legs for bolting unit to floor of UTV - Add \$45.00 *
 - Hydraulic agitation - Add \$95.00*

Note: To completely evacuate tank, use wet/dry vac



Ultra Low Profile 75-Gallon UTV Sprayer WC75ULP6 \$3,677.00*

- Internal sump • Honda GX120 engine with roller pump, 10 gpm and 250 psi max pressure
- Double boomless nozzles with 30' (15' right, 15' left) spray pattern controlled with 12-volt solenoid valves from cab • 15' of hose and pistol grip handgun • Fits in most long UTVs and has a low center gravity • Tank measures 36" L x 48" W x 12" H

- Options:**
- Manual hose reel with 100' of 3/8" hose - Add \$465.00*
 - Manual hose reel with 50' of 3/8" hose - Add \$252.00*
 - Legs for bolting unit to floor of UTV - Add \$45.00*
 - Oil Drainzit - Add \$29.80*
 - Hydraulic agitation - Add \$95.00*

Note: To completely evacuate tank, use wet/dry vac

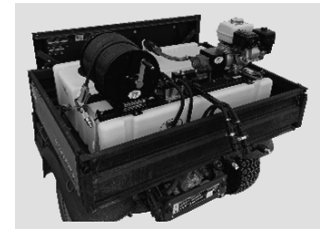

GENERAL PURPOSE SPOT SPRAYERS

Portable spray units featuring flat bottom 14 or 25-gallon poly tanks. Allows placement in pickup bed and universal mounting on ATV rack. 12-volt on demand pump operating at 45 psi. Premium quality trigger operated spray gun with adjustable nozzle capable of straight stream or wide angle and 15' of hose.

14-gallon spot sprayer, 1.0 gpm pump	WCATV141	\$168.00
14-gallon spot sprayer, 1.8 gpm pump	WCATV141.8	268.00
14-gallon spot sprayer, 1.8 gpm pump with two nozzles 80" swath boom, 15 gpa @ 5 mph, 19 gpa @ 4 mph	WCATV141.880	378.00
25-gallon spot sprayer, 1.0 gpm pump	WCATV251	238.00
25-gallon spot sprayer, 1.8 gpm pump	WCATV251.8	291.00
25-gallon spot sprayer, 1.8 gpm pump with two nozzles 80" swath boom, 15 gpa @ 5 mph, 19 gpa @ 4 mph	WCATV251.880	404.00
25-gallon spot sprayer, 3.0 gpm pump	WCATV253	366.00
25-gallon spot sprayer, 3 gpm pump, 12' swath boom, spring loaded break away boom, 15 gpa @ 5 mph, 19 gpa @ 4 mph	WCATV25312	850.00
25-gallon spot sprayer, 3.0 gpm pump, Boominator nozzle providing up to 16' spray pattern from a single tip, 14 gpa @ 5 mph, 18 gpa @ 4 mph	WCATV253B	462.00



14 GAL
Two nozzle
80" swath
boom



25 GAL
144" swath boom
with break away
wings

JACKRABBIT and COTTONTAIL ATV SPRAYERS

Molded tanks to fit the contour of an ATV and to give maximum dispersion of weight, universal mounting and 12-volt pump

Jackrabbit

24.5-gallon molded tank

Cottontail

15-gallon molded tank

WC2412HG - \$568.00

Equipped with 1.4 or 1.8 gpm pump, control switch, 15' of hose and Black Jewel handgun



WC15CT - \$1,105.00

Equipped with 4.5 gpm pump, control switch, 15' of hose, Black Jewel handgun, two boomless nozzles producing a 30' swath (15' to right and 15' to left) and on/off right/left control valves

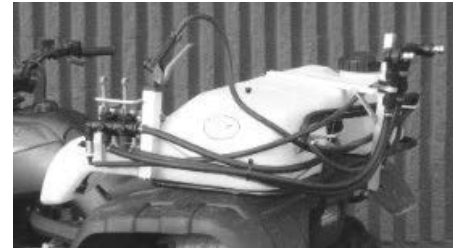

WC2412FJ - \$865.00

Equipped with 3 gpm pump, control switch, 15' of hose, Black Jewel handgun, single boomless nozzle delivering an approximate 16' swath, manual on/off valve, 12 gpa @ 4 mph, 10 gpa @ 5 mph



Jackrabbit and Cottontail ATV Sprayer Options

- JD9 handgun in place of Black Jewel - Add \$89
- JD9PT handgun in place of Black Jewel - Add \$89
- Front rack mounted manual hose reel and 100' hose with hose reel feed line; mounting hardware not included - Add \$465.00

WC241212 - \$1,155.00

Equipped with 3 gpm pump, control switch, 15' of hose, Black Jewel handgun, 12' folding boom with on/off valve, gauge, pressure control, 12 gpa @ 4 mph, 10 gpa @ 5 mph



Hardware

- 15' slinky hose - \$63.00*
- External strainer sub-assembly - \$24.80*
- Boomless nozzle mount - \$68.00*
- Boomless nozzle mount & plumbing - \$121.00*
- Plumbing (no nozzles) - \$48.00*
- Valve plate - \$74.40*
- Hose hanger - \$19.80* each
- Replacement push button switch - \$16.20 each

WC2412BB - \$1,155.00

Equipped with 4.5 gpm pump, control switch, 15' of hose, Black Jewel handgun, two boomless nozzles producing a 30' swath (15' right, 15' left), and on/off right/left control valves



Notes

- Tie downs and/or straps not included
- ATV must produce 12 amps to operate 4 and 5 gpm pumps
- 12-gauge wiring to the battery is required for 4 and 5 gpm pumps and 30-amp fuse or breaker
- Recommend the use of *Direct* drift retardant/disposition aid to reduce fine droplets
- Refer to ATV specifications to ensure load capacity will handle the Jackrabbit, Cottontail and Pro models
- Units shipped by common carrier

JACKRABBIT PRO and COTTONTAIL PRO ATV SPRAYERS

All the fine spray features of the standard Jackrabbit and Cottontail ATV sprayers with upgrades for the professional applicator. Refer to ATV specifications to ensure load capacity will handle the Jackrabbit, Cottontail and Pro models.

Jackrabbit Pro \$1,298.00



Standard Features

- 24.5-gallon contoured design tank for better weight distribution and safety
- Double boomless nozzles for right or left spraying or a 30' total swath with adjustable nozzles for efficient spraying
- Right and left control valves
- 12-volt diaphragm pump • Black Jewel handgun

Jackrabbit Pro Upgrades from Standard Jackrabbits

1/4 turn ball valves under each leg allowing maximum amount of solution to be used out of the tank no matter what the terrain.



Handgun hose is upgraded to a 15' slinky type hose giving ease of operation when operating the ATV and sprayer



Cottontail Pro \$1,220.00



Standard Features

- 15-gallon contoured design tank for better weight distribution and safety
- Double boomless nozzles for right or left spraying or a 30' total swath with adjustable nozzles for efficient spraying
- Right and left control valves
- 12-volt diaphragm pump • Black Jewel handgun

Features the upgraded 12-volt quad sensor pump. The pump has a built-in micro switch control that increases or decreases flow on nozzle demand, thus producing a near constant pressure regardless of the number of nozzles spraying. This puts less demand on the ATV battery and charging system, pump motor will have longer life, and provides excellent performance in operating boomless spray nozzles.



Agitation/Mixing Kit

For Retrofitting 24.5-gallon Jackrabbit and Jackrabbit Pro ATV Sprayers and 12-volt UTV Sprayers

Includes two mini agitators, bung fitting, on/off valve, all hoses and fittings. For mixing and agitating, dissolving granules, wettable powder or flowable liquids. Valve actuates agitation system when boomless nozzle and handgun are not in use. Harness and agitator fit inside the tank. **\$174.00**

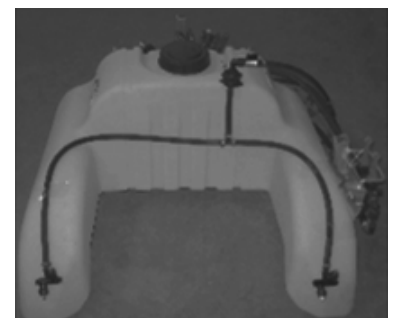

Mini-Agitator

Double agitator kit for use on ATV and UTV sprayers with 12-volt low volume pumps. Also use where hydraulic agitation is needed but pump does not produce enough volume to use standard agitation.

WCMINI01 Nylon body **\$56.00**

CHEMICAL MIXING UNIT

Designed to transfer and mix water or liquid fertilizer from supply tank to spray applicator. Takes the work out of hauling dry ammonium sulfate and other chemical to the top of sprayer for mixing.

- 55-gallon inductor cone tank
- Fills and mixes in cone
- Stinger for extracting out of shuttles or barrels to cone
- Garden hose attachment for washing and rinse
- Garden hose and/or nozzle, or jet rinser not included



GX160 Honda engine with 2" pump unit - \$2,475.00*
2 hp electric 115/220 with 2" pump unit - 2,710.00*
 15' of 3/4" hose and Jet Rinse Nozzle - \$56.00*

FORAGE APPLICATOR

General purpose for mounting on bailer or swather
 • Poly tank • 12-volt pump • On/off switch • Hose/nozzle

25-gallon with on/off switch - \$692.00*
40-gallon with on/off switch - \$797.00*
60-gallon with on/off switch - \$833.00*
40-gallon with rheostat - \$1,067.00*
60-gallon with rheostat - \$1,131.00*



MSC 30-NG rheostat with 10' power cord and 15' cable and 30-amp - \$361.00

SEED TREATER

Treat your seed with this 5-gallon unit. Comes complete with cone bottom tank for complete clean out, 12-volt Shurflo pump, bypass pressure adjustment, filter, gauge, hose, and nozzles.



500 ST05A 12-Volt \$624.00*
500 ST05B 110-Volt \$679.00*

Liquid Feed Applicator Kit for Bale Processors and Grinders - \$4,925.00*



Hydraulic driven, 1.5" gear pump kit for applying liquid feed to forage • 75-gallon tank designed to self-load and unload tank • Needle valve hydraulic flow adjustable rate
 • Two TeeJet nozzles included for high/low range of adjustments • Hydraulic hoses and quick couplers not included in kit

Planter Kits for Banding Liquid Starter Fertilizer

8-row hose, fittings, orifices and check valves - \$652.00*
 12-row hose, fittings, orifices and check valves - \$804.00*
 Tube holder to be custom ordered to fit model of planter - \$21.00* to \$45.00*
 3.0 gpm 12-volt fertilizer pump unit with plumbing - \$501.00*
 5.3 gpm 12-volt fertilizer pump unit with plumbing - \$574.00*



ELSTON GOPHER GETTER

Pocket gophers cost you money! Every day they run free they destroy your profit potential. It builds and baits artificial runways so only gophers can get it. There is no better way to control pocket gophers. Field tested and customer approved for over three decades - it is the industry standard!



- GA-400-22, 3-point hitch tractor mount - \$3,065.00
- GA-500-20, pull type (hydraulic cylinder not included) - \$4,210.00
- GA-700, 3-point hitch Cat 1 & 2, heavy duty - \$4,910.00
- GA-600, hand-held model - \$329.00
- Kaput Big Boy gopher probe - \$97.00
- 1 lb jar non-restricted .5% strychnine bait (fits in hand held model) - \$17.30
- 4 lb container .5% strychnine bait - \$49.00
- 45 lb bucket .5% strychnine bait - \$296.00
- 30 lb bucket Kaput - \$94.10
- 5 lb pail Kaput - \$32.90



PRAIRIE DOG BAITER \$730.00*



Fastest, easiest, and most economical way to control prairie dogs. Commercial applicator that works great for landowners with large areas to treat. Does up to 200 holes per hour or 10 acres per hour (based on 20 holes per acre). Heavy 5-gallon poly tank. Holds up to 30 lbs plus of treated grain.

UTV mounting bracket for prairie dog baiter \$125.00

HONDA ENGINES AND ACCESSORIES



GX Series Horizontal Shaft



Model	Type	Feature	Price
GX120	HX2	6:1 gear reduction, 3/4"	\$ 589.00
GX120	QX2	Standard shaft, 3/4"	412.00
GX160	QX2	Standard shaft, 3/4"	393.00
GX160	HX2	6:1 gear reduction, 3/4"	585.00
GX160	QXE2	Electric start, 3/4"	685.00
GX160	TX2	Threaded shaft, 5/8"	441.00
GX200	QX2	Standard shaft, 3/4"	454.00
GX200	QXE2	Electric start, 3/4"	779.00
GX240	HA2	6:1 gear reduction, 1"	917.00
GX270	PAE2	Threaded, electric start, 1"	859.00
GX270	PA2	Threaded, pull start, 1"	817.00
GX270	QAE2	Electric start, 1"	973.00
GX270	QA2	Standard shaft, 1"	752.00
GX390	QAE2	Electric start, 1"	1,059.00
GX630	RQ2E	Electric start, 1"	1,899.00

Larger engines available, please inquire

Options For GX630 Honda Engines

Part Number	Description	Price
MUF-0560.SIL	Muffler right discharge	\$189.00
MUF-0560.SIR	Muffler left discharge	189.00
071237CE.FLA	6-gallon remote mount fuel tank kit with carbon filter	281.00

Replacement Recoil Assemblies

Part Number	Description	Price
28400-Z4M-3052B	For GX120, GX160, GX200	\$18.21
28400-ZH8-013YA	For GX120, GX160, GX200	97.44
28400-Z4M-306ZB	For GX120, GX160, GX200	13.45
28400-ZM7-003	For GX50	30.37
28400-ZL8-023ZA	For GC160, GC190	26.60

Air Filters

Part Number	Description	Price
17210-ZE3-505	For GX340, GX390	\$18.52
17210-ZE2-515	For GX240, GX270	13.70
17210-ZE2-822	For GX240, GX270	13.70
17210-Z4M-821	For GX120, GX160, GX200	8.38
17211-ZM7-000	For GX50	1.64
17210-ZJ1-842	For GX620, GX670	54.90

Spark Plug

Part Number	Description	Price
98079-56846	For GX120 thru GX390	\$6.90
98079-5587G	For GX630 thru GX690	6.90

Drainz it[™] Oil Drain Hoses

- Fits Honda and Briggs & Stratton Engines
- Ends messy oil changes

Honda 1008	8mm oil port	For GX50	\$29.80
Honda 1010	10mm oil port	For GX100, GX140, GX160, GX200	29.80
Honda 1012	12mm oil port	For GX240, GX270, GX340, G390, GC160	29.80
Honda 1420	20mm oil port	For Honda V-Twin engines	29.80
B&S 1025	1/4" NPT	For all B&S and Tecumseh engines	29.80

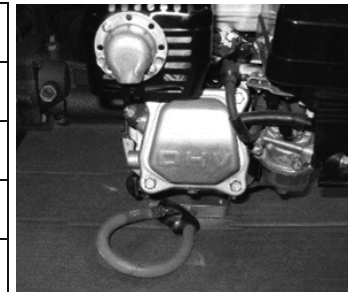

PRIZELAWN COMMERCIAL SPREADERS AND ACCESSORIES

CBR IV "Commercial Broadcast Spreader"

- 70+ lb capacity • 13" Turf Tracker pneumatic tires
- Improved ergonomic handle • Adjustable chute for spread pattern control • Spring loaded on/off
- Gear cover standard • Hopper cover included
- Side deflector optional • Limited lifetime warranty on gears



Stainless Steel Frame - \$620.00*
Epoxy Powder Coat Frame - \$540.00*

LF II "LiIFOOT" - \$209.00*

- Up to 40 lb capacity • 10" pneumatic tires • Spring loaded on/off • Epoxy powder coat welded frame
- Hopper cover included • Unbeatable value in a light duty commercial spreader



PrizeLawn Spreader Options and Parts

Part #	Description	Price
33117	Agitator	\$9.75
14832-Kit	Axle gear kit	31.90
1514404	Chute/guide set	34.00
14837-Kit	Gear cover kit	58.75
77003	Hopper cover	49.00
18128	Hopper screen	22.50
15972	Ice melt deflector for CBR IV	71.00
15524	Impeller assembly	55.00
14833-Kit	Pinon gear kit	31.90
	Receiver hitch carrier for CBR IV	131.00
15681	Side deflector kit for CBR IV	133.00
15209	LiIFOOT hopper cover	43.50

HERD GT-77 SEEDER

Standard Features

- Heavy duty one piece iron base • Hopper capacity of 77 lbs fertilizer or 1.2 bushel seed
- Stain-less steel pivot plate for years of service • 4-bladed corrosive resistant aluminum fan
- 12-volt electric motor (spreads alfalfa 28' wide) • Hopper lid to keep material in hopper and dry at all times • Vibrating agitator for sure-feed of material being spread • Mounting kits to fit most all ATVs • Includes bracket for metal ATV rack "T"

Options

Part #	Description	Price
544	3-point hitch for GT-77 in place of ATV bracket	\$192.00*
660	2" receiver hitch for GT-77 in place of ATV bracket	250.00*
811	Rheostat to control spread width	175.00*
JPH-1	UTV with tailgate and 2" receiver (JD Gator, Kubota, etc) in place of standard mounting kit	315.00*



\$785.00*



DOSATRON

WATER POWERED DOSING TECHNOLOGY

Affordable, on-sprayer chemical injection



- No more messy mixing chores. • No more left-over spray solution at the end of the day. • Just fill your sprayer tank with water and set the Dosatron to the desired percentage of chemical to water • The Dosatron chemical injector precisely injects the pre-set amount of chemical into the flow of water being pumped to the nozzles. This percentage of chemical to water remains constant regardless of changes in spray pump output.
- On sprayers equipped with automatic spray rate control systems, the Dosatron rate of chemical injection precisely follows the changes in flow and pressure called for by the spray rate control system.

Model	Flow Rate	Flow Range	Pressure	Ratios	Percentage	Oz / Gal	Price
D14M22	14 gpm	0.05 to 14 gpm	4.3 to 85 psi	1:500 to 1:50	0.2 to 2	.256 to 2.56	\$590.00*
D14M25	14 gpm	0.05 to 14 gpm	4.3 to 85 psi	1:200 to 1:20	0.5 to 5	.64 to 6.4	1,200.05*
D45RE15	20 gpm	.5 to 20 gpm	7 to 70 psi	1:500 to 1:66	0.2 to 1.5	.256 to 1.92	761.63*
D45RE3	20 gpm	.5 to 20 gpm	7 to 70 psi	1:200 to 1:33	0.5 to 3.0	.64 to 3.84	1,132.12*

	D8R	DSA45-1.5	DSA45-3	D14M22	D14M25
Dosing Seal Kit	8PJ052VF \$62.00*	PJ096VF \$83.00*	PJ084AF \$119.00*	PJDI116VF \$71.83*	PJDI20VAF \$123.00*
Motor Seal Kit	8EM002 \$11.75*	MKD45RE15 \$125.00*	MKD45RE3 \$166.00*	EMDI006VF \$46.00*	EMDI006VF \$46.00*

PERSONAL PROTECTION EQUIPMENT

Tyvek Coveralls

Non-elastic wrists and ankles.
Full zipper front

BW1921 M - XL \$8.60 per pair
BW1921 2X \$9.10 per pair
BW1921 3X \$10.25 per pair



PVC Bib Chemical Apron

BW1971EA \$17.90 each

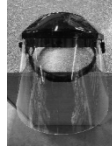

Full Face Shield

Positive lock headgear FE2000EA \$36.60

Replacement Shield

FE2001EA \$5.05

Heavy Duty Nitrile Gloves

HW2300 \$22.75 per pair
19" elbow length, 22 mil thickness, L and XL



Minuteman Universal Spill Response Duffel

SP30GA-MIN \$152.00

Contains: 2 – 26"x16"x2" pillows;
3 – 3"x48" diking tubes; 1 pair 15
mil nitrile gloves; 1 pair safety
goggles; 1 pair rubber hazmat
boots, 2 disposal bags with labels



Nitrile Gloves

13" cuff, 15 mil thickness

HW2400 S - XL \$3.55 per pair
HW2400 2XL \$3.70 per pair



Gloveworks Disposable

Nitrile Gloves

Textured grip, 8 mil thickness
M - 2XL \$46.00 per box of 100



Commando Universal Spill Response Kit

SP30GA-COM \$102.00

Fits behind pickup seat. Contains: 2 ea
3"x48" diking tubes; 4 ea 16"x9"x2" pillows;
1 pair safety goggles; 1 pair boot covers; 1
pair 15 mil nitrile gloves; 2 disposal bags;
instruction sheet



Safety Glasses

One-piece wraparound lens,
Flexible temples, Temple sleeves

FE4045C Clear \$4.45 per pair
FE4045G Grey Tint \$3.85 per pair

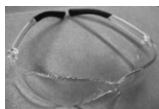

Warne Rapid Response Spill Kit ~ \$925.00

- 53-gallon lockable tote
- HookLok mounts for shovel
- D-handle pointed shovel
- D-handle square end shovel
- Floor Dry, 24-quart bag (x 2)
- Hand soap (one liquid, one bar Lava)

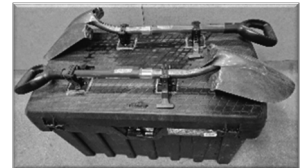

Safety Goggles, Indirect Vent

Can be worn with half-mask
respirator. Fits over
prescription eyewear.

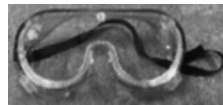

\$5.40 per pair

North Half-Mask Respirator Kit (M&L)

Comes with mask, one set each
of organic vapor cartridges,
R95 prefilters, and filter covers



RSKT7700N ~ \$88.50
RS7501NPK ~ Organic vapor cartridge, 1 pair
\$20.80 / pair
RS7506RNBX ~ R95 prefilters, 10 pack
\$51.40 / pack
RS700NPK ~ Prefilter cover, 1 pair
\$7.00 / pair



- N95 dust mask (x 6)
- Safety glasses (one pair)
- Paper towels (one roll)
- Roll of 30-gallon trash bags
- Shoe covers

N95 Particulate Respirator

Molded mask, resists collapsing

RS2120BX-AL ~ \$52.25 per box of 20
RS2120 ~ Individually, \$2.90 each



- Collapsible shovel
- Diking tubes 4' x 3-1/2" (x 12)
- Sorbent pillows 8-1/2" x 8-1/2" (x 10)
- Oil sorbent pads 8-1/2" x 17-1/2" (x 10)
- Tyvek suit (one XL, one XXL)



“HANDS FREE” hose pulling with the original hose harness

HotStop

- For all commercial hose uses
- Reduce back and shoulder fatigue
- Eliminate hose being slung over shoulder lessening exposure from hose contact
- Micro and macro adjustment to hose up to 1-1/4" OD
- Switch between hose or cord in seconds
- Fully adjustable from approximately 5/16" to 1-1-4"
- Great for "non-gasoline" powered tools and equipment
- \$35.00* each; \$29.90* each 3 or more



BigStop

- For all hose and cord uses
- Switch between hose or cord in seconds
- Reduce fatigue and increase productivity
- Adjustable belt with quick-release buckle
- Fully adjustable from approximately 5/16" to 1-1/4" OD
- Great for "non-gasoline" powered tools and equipment
- \$27.90* each; \$23.90* each 3 or more



ROOT FEEDERS

Standard Root Feeder

\$356.00*

XL Root Feeder (10" longer)

\$366.00*

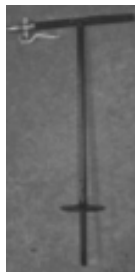

Ideal for injecting liquid fertilizer into hard, compact soils. Features welded steel step, two-hole chisel tip design on injector point assembly, non-slip handle grips and trigger valve with 1/2" FP inlet.

- Replaceable trigger valve - \$189.00*
- Replaceable hardened steel tip - \$75.00*
- 1/2" male quick coupler - \$17.00*
- 1/2" female coupler for hose - \$29.00*
- Trigger valve repair kit - \$37.00*
- 305A squeeze lever/bracket assembly - \$39.70*

WeatherFlow Weather Meter

Simple and cost-effective way to capture location specific weather data.

WEATHERmeter - \$79.85*

- Communicates via Bluetooth up to 100'
- Readings are recorded and displayed to WINDmeter app (free or compatible app)
- Wind speed (average, gust) 2-125 mph
- Wind direction
- Crosswind, headwind, tailwind
- Temperature and relative humidity
- Pressure and dew point
- Heat index, windchill and more



SOIL CORE SAMPLER - \$99.00*



- 36" tube with 12" T handle
- 3/4" diameter side outlet core discharge

HANDHELD WEED WIPER

Air poly weed wiper for use around trees, bushes and gardens. Just add one part Roundup with two parts water.

Order No 500HWW \$45.00*



FLUID FILM not only protects against, and stops rust, but also is capable of penetrating heavily corroded and/or frozen parts such as nuts bolts, shafts, and more. Will not evaporate or dry out. Use on metals, wood, leather, and electrical. Penetrates and protects immediately after application. Non-toxic, non-hazardous and user friendly.



- 11.75 oz aerosol can - \$14.50 per can
- Case of twelve 11.75 oz aerosol cans - \$152.00 per case
- 8 oz brush can - \$20.50 per can
- 1 gallon bulk can - \$97.50 per can

EARTHWAY BELLY GRINDER

GRASS SEEDER

- 20 lb capacity
 - Nylon bag
- Model 2750 - \$61.00*



MIRACLE RUST AWAY

For removal of rust deposit stains on poly spray tanks, fiberglass, wood, stone, masonry, metal, and assorted painted surfaces.

- Quart \$16.90
- Gallon \$46.00



JET RINSE NOZZLE

Rinses cans of chemicals and prevents re-use, works on metal or plastic cans. Has 3/4" garden hose thread female inlet connection and on/off slide switch.

\$38.83*



MEASURING CONTAINERS



- 128 oz \$20.50*
- 64 oz \$12.50*
- 34 oz \$10.75*
- 8 oz \$8.75*

CUSTOM BUILT SPRAYERS TO FIT YOUR NEEDS AND BUDGET



**FLATBED MOUNTED TREE, TURF AND
ROADSIDE SPRAYERS**



**PICKUP MOUNTED
TREE AND TURF SPRAYERS**

Let Warne Companies professional staff custom design and build a sprayer to **YOUR** specifications. Call 1-605-342-7644 for a custom quote!



**BOOMLESS RANGE AND PASTURE
42' boomless coverage**



ATV SPRAYERS - 15 AND 24.5-GALLON



AGRICULTURAL SPRAYERS

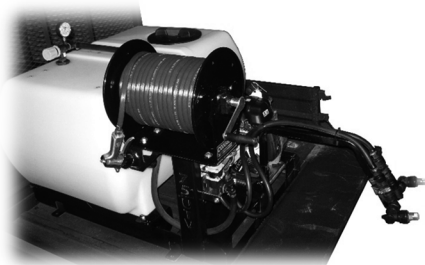

UTV SPRAYERS - 55, 75, 100-GALLON



Meet Our Sales Staff . . .
With a combined experience of 180 plus years

AARON LONDON

Email: aaron@warneusa.com
 Web: www.warneusa.com
 Phone: 605-342-7644

NEVIN PRICE

Email: nevin@warneusa.com
 Web: www.warneusa.com
 Phone: 605-342-7644

TIMM JOHANNESSEN

Email: tim@warneusa.com
 Web: www.warneusa.com
 Phone: 605-342-7644



2610 Commerce Rd
 Rapid City SD 57702
 605-342-7644
www.warneusa.com

MARK FANNING

Email: mark@warneusa.com
 Web: www.warneusa.com
 Phone: 605-342-7644

LESTER NIELSON

Email: lester@warneusa.com
 Web: www.warneusa.com
 Phone: 605-342-7644

TAYLOR GUST

Email: taylor@warneusa.com
 Web: www.warneusa.com
 Phone: 605-342-7644



On the new
www.warneusa.com
you can . . .



- Order sprayers, parts, tanks, hose, handguns, pumps, engines, pesticides and fertilizers, applicator safety equipment (PPE), and more
- Get industry updates, expert tips, and advise



- Make payments



NOTES

HAVE QUESTIONS, CALL US AT 605-342-7644



WARNE



2610 Commerce Rd • Rapid City SD 57702

Phone: 605-342-7644

Email: warnechemical@warnechemical.com

Website: www.warneusa.com

